

Algebra Connections Extra Practice

Managing Editors

Leslie Dietiker
Phillip and Sala Burton
Academic High School
San Francisco, CA

Evra Baldinger
Phillip and Sala Burton
Academic High School
San Francisco, CA

Editor of Extra Practice

Bob Petersen
Rosemont High School
Sacramento, CA

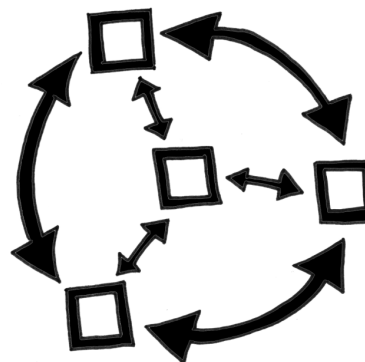

Contributing Editors

Carlos Cabana
San Lorenzo High School
San Lorenzo, CA

John Cooper
Del Oro High School
Loomis, CA

Joanne da Luz
The Life Learning Academy
San Francisco, CA

David Gulick
Phillips Exeter Academy
Exeter, NH

Patricia King
Holmes Junior High School
Davis, CA

Lara Lomac
Phillip and Sala Burton Academic High
School, San Francisco, CA

Bob Petersen
Rosemont High School
Sacramento, CA

Ward Quincey
Gideon Hausner Jewish Day School,
Palo Alto, CA

Barbara Shreve
San Lorenzo High School
San Lorenzo, CA

Michael Titelbaum
University of California
Berkeley, CA

Illustrator

Kevin Coffey
San Francisco, CA

Technical Manager

Bethany Armstrong
Davis, CA

Technical Assistants

Erica Andrews	Eric Baxter
Elizabeth Burke	Carrie Cai
Elizabeth Fong	Rebecca Harlow
Keith Lee	Michael Leong

Program Directors

Leslie Dietiker
Phillip and Sala Burton Academic High School
San Francisco, CA

Judy Kysh, Ph.D.
Departments of Mathematics and Education
San Francisco State University

Brian Hoey
Christian Brothers High School
Sacramento, CA

Tom Sallee, Ph.D.
Department of Mathematics
University of California, Davis

Consultants from San Lorenzo High School

Ashanti Branch	Laura Evans	Eric Price	Estelle Woodbury
Suzanne Cristofani	Lisa Jilk	Ana Ruiz	Dorothy Woods
Kristina Dance	Karen O'Connell	Hannah Witzemann	Lisa Wright

Copyright © 2008 by CPM Educational Program. All rights reserved. No part of this publication may be reproduced or transmitted in any form or by any means, electronic or mechanical, including photocopy, recording, or any information storage and retrieval system, without permission in writing from the publisher. Requests for permission should be made in writing to: CPM Educational Program, 1233 Noonan Drive, Sacramento, CA 95822. Email: cpm@cpm.org.

1 2 3 4 5 6 7 8 9 14 13 12 11 10 09 08

Printed in the United States of America

Version 3.0

ISBN 978-1-60328-002-0

Extra Practice

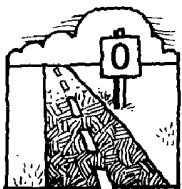

ALGEBRA CONNECTIONS

EXTRA PRACTICE

Introduction to Students and Their Teachers

Learning is an individual endeavor. Some ideas come easily; others take time--sometimes lots of time--to grasp. In addition, individual students learn the same idea in different ways and at different rates. The authors of this textbook designed the classroom lessons and homework to give students time--often weeks and months--to practice an idea and to use it in various settings. The Extra Practice resource offers students a brief review of 29 topics followed by additional practice with answers. Not all students will need extra practice. Some will need to do a few topics, while others will need to do many of the sections to help develop their understanding of the ideas. This resource for the text may also be useful to prepare for tests, especially final examinations.

How these problems are used will be up to your teacher, your parents, and yourself. In classes where a topic needs additional work by most students, your teacher may have everyone do some of these problems. In most cases, though, the authors expect that these resources will be used by individual students who need to do more than the textbook offers to learn or reinforce an idea. This will mean that you are going to need to do some extra work outside of class. In the case where additional practice is necessary for you individually or for a few students in your class, you should not expect your teacher to spend time in class going over the solutions to the extra practice problems. After reading the examples and trying the problems, if you still are not successful, talk to your teacher about getting a tutor or extra help outside of class time.

Warning! Looking is not the same as doing. You will never become good at any sport just by watching it. In the same way, reading through the worked out examples and understanding the steps is not the same as being able to do the problems yourself. An athlete only gets good with practice. The same is true of developing your algebra skills. How many of the extra practice problems do you need to try? That is really up to you. Remember that your goal is to be able to do problems of the type you are practicing on your own, confidently and accurately.

Another source for help with the topics in this course is the *Parent's Guide with Review to Algebra Connections*. It is available free on the Internet or may be ordered at www.cpm.org. Homework help is provided at www.hotmath.com.

Extra Practice

Extra Practice Topics

1. Arithmetic operations with numbers
2. Combining like terms
3. Order of operations
4. Distributive Property
5. Substitution and evaluation
6. Tables, equations, and graphs
7. Solving linear equations
8. Writing equations
9. Solving proportions
10. Proportional reasoning: ratio applications
11. Intersection of lines: substitution method
12. Multiplying polynomials
13. Writing and graphing linear equations
14. Intersections of lines: elimination method
15. Factoring polynomials
16. Zero Product Property and quadratics
17. The quadratic formula
18. Solving inequalities
19. Absolute value equations
20. Absolute value inequalities
21. Simplifying rational expressions
22. Multiplication and division of rational expressions
23. Solving equations containing algebraic fractions
24. Completing the square
25. Laws of exponents
26. Addition and subtraction of rational expressions
27. Solving mixed equations and inequalities
28. Pythagorean Theorem
29. Simplifying square roots
30. Problem involving rate, work, and percent mixture

Extra Practice

ARITHMETIC OPERATIONS WITH NUMBERS

#1

Adding integers: If the signs are the same, add the numbers and keep the same sign. If the signs are different, ignore the signs (that is, use the absolute value of each number) and find the difference of the two numbers. The sign of the answer is determined by the number farthest from zero, that is, the number with the greater absolute value. Also see the textbook, page 15.

same signs

a) $2 + 3 = 5$ or $3 + 2 = 5$

b) $-2 + (-3) = -5$ or $-3 + (-2) = -5$

different signs

c) $-2 + 3 = 1$ or $3 + (-2) = 1$

d) $-3 + 2 = -1$ or $2 + (-3) = -1$

Subtracting integers: To find the difference of two values, change the subtraction sign to addition, change the sign of the number being subtracted, then follow the rules for addition.

a) $2 - 3 \Rightarrow 2 + (-3) = -1$

c) $-2 - 3 \Rightarrow -2 + (-3) = -5$

b) $-2 - (-3) \Rightarrow -2 + (+3) = 1$

d) $2 - (-3) \Rightarrow 2 + (+3) = 5$

Multiplying and dividing integers: If the signs are the same, the product will be positive. If the signs are different, the product will be negative.

a) $2 \cdot 3 = 6$ or $3 \cdot 2 = 6$

b) $-2 \cdot (-3) = 6$ or $(+2) \cdot (+3) = 6$

c) $2 \div 3 = \frac{2}{3}$ or $3 \div 2 = \frac{3}{2}$

d) $(-2) \div (-3) = \frac{2}{3}$ or $(-3) \div (-2) = \frac{3}{2}$

e) $(-2) \cdot 3 = -6$ or $3 \cdot (-2) = -6$

f) $(-2) \div 3 = -\frac{2}{3}$ or $3 \div (-2) = -\frac{3}{2}$

g) $9 \cdot (-7) = -63$ or $-7 \cdot 9 = -63$

h) $-63 \div 9 = -7$ or $9 \div (-63) = -\frac{1}{7}$

Follow the same rules for fractions and decimals.

Remember to apply the correct order of operations when you are working with more than one operation.

Simplify the following expressions using integer operations WITHOUT USING A CALCULATOR.

1. $5 + 2$

2. $5 + (-2)$

3. $-5 + 2$

4. $-5 + (-2)$

5. $5 - 2$

6. $5 - (-2)$

7. $-5 - 2$

8. $-5 - (-2)$

9. $5 \cdot 2$

10. $-5 \cdot (-2)$

11. $-5 \cdot 2$

12. $2 \cdot (-5)$

13. $5 \div 2$

14. $-5 \div (-2)$

15. $5 \div (-2)$

16. $-5 \div 2$

17. $17 + 14$

18. $37 + (-16)$

19. $-64 + 42$

20. $-29 + (-18)$

21. $55 - 46$

22. $37 - (-13)$

23. $-42 - 56$

24. $-37 - (-15)$

25. $16 \cdot 32$ 26. $-42 \cdot (-12)$ 27. $-14 \cdot 4$ 28. $53 \cdot (-10)$
 29. $42 \div 6$ 30. $-72 \div (-12)$ 31. $34 \div (-2)$ 32. $-60 \div 15$

Simplify the following expressions without a calculator. Rational numbers (fractions or decimals) follow the same rules as integers.

33. $(16 + (-12))3$ 34. $(-63 \div 7) + (-3)$ 35. $\frac{1}{2} + (-\frac{1}{4})$
 36. $\frac{3}{5} - \frac{2}{3}$ 37. $(-3 \div 1\frac{1}{2})2$ 38. $(5 - (-2))(-3 + (-2))$
 39. $\frac{1}{2}(-5 + (-7)) - (-3 + 2)$ 40. $-(0.5 + 0.2) - (6 + (-0.3))$ 41. $-2(-57 + 71)$
 42. $33 \div (-3) + 11$ 43. $-\frac{3}{4} + 1\frac{3}{8}$ 44. $\frac{4}{5} - \frac{6}{8}$
 45. $-2(-\frac{3}{2} \cdot \frac{2}{3})$ 46. $(-4 + 3)(2 \cdot 3)$ 47. $-\frac{3}{4}(3 - 2) - (\frac{1}{2} + (-3))$
 48. $(0.8 + (-5.2)) - 0.3(-0.5 + 4)$

Answers

1. 7 2. 3 3. -3 4. -7
 5. 3 6. 7 7. -7 8. -3
 9. 10 10. 10 11. -10 12. -10
 13. $\frac{5}{2}$ or $2\frac{1}{2}$ or 2.5 14. $\frac{5}{2}$ or $2\frac{1}{2}$ or 2.5 15. $-\frac{5}{2}$ or $-2\frac{1}{2}$ or -2.5 16. $-\frac{5}{2}$ or $-2\frac{1}{2}$ or -2.5
 17. 31 18. 21 19. -22 20. -47
 21. 9 22. 50 23. -98 24. -22
 25. 512 26. 504 27. -56 28. -530
 29. 7 30. 6 31. -17 32. -4

 33. 12 34. -12 35. $\frac{1}{4}$ 36. $-\frac{1}{15}$
 37. -4 38. -35 39. -5 40. -6.4
 41. -28 42. 0 43. $\frac{5}{8}$ 44. $\frac{2}{40} = \frac{1}{20}$
 45. 2 46. -6 47. $1\frac{3}{4}$ 48. -5.45

COMBINING LIKE TERMS

#2

Like terms are algebraic expressions with the same variables and the same exponents for each variable. Like terms may be combined by performing addition and/or subtraction of the coefficients of the terms. Also see the textbook, page 57.

Example 1

$(3x^2 - 4x + 3) + (-x^2 - 3x - 7)$ means combine $3x^2 - 4x + 3$ with $-x^2 - 3x - 7$.

1. To combine horizontally, reorder the six terms so that you can add the ones that are the same: $3x^2 - x^2 = 2x^2$ and $-4x - 3x = -7x$ and $3 - 7 = -4$. The sum is $2x^2 - 7x - 4$.
2. Combining vertically:

$$\begin{array}{r} 3x^2 - 4x + 3 \\ -x^2 - 3x - 7 \\ \hline 2x^2 - 7x - 4 \end{array}$$

is the sum.

Example 2

Combine $(x^2 + 3x - 2) - (2x^2 + 3x - 1)$.

First apply the negative sign to each term in the second set of parentheses by distributing (that is, multiplying) the -1 to all three terms.

$$-(2x^2 + 3x - 1) \Rightarrow (-1)(2x^2) + (-1)(3x) + (-1)(-1) \Rightarrow -2x^2 - 3x + 1$$

Next, combine the terms. A complete presentation of the problem and its solution is:

$$\begin{aligned} (x^2 + 3x - 2) - (2x^2 + 3x - 1) &\Rightarrow x^2 + 3x - 2 - 2x^2 - 3x + 1 \\ &\Rightarrow -x^2 + 0x - 1 \Rightarrow -x^2 - 1. \end{aligned}$$

Combine like terms for each expression below.

1. $(x^2 + 3x + 4) + (x^2 + 4x + 3)$
2. $(2x^2 + x + 3) + (5x^2 + 2x + 7)$
3. $(x^2 + 2x + 3) + (x^2 + 4x)$
4. $(x + 7) + (3x^2 + 2x + 9)$
5. $(2x^2 - x + 3) + (x^2 + 3x - 4)$
6. $(-x^2 + 2x - 3) + (2x^2 - 3x + 1)$
7. $(-4x^2 - 4x - 3) + (2x^2 - 5x + 6)$
8. $(3x^2 - 6x + 7) + (-3x^2 + 4x - 7)$
9. $(9x^2 + 3x - 7) - (5x^2 + 2x + 3)$
10. $(3x^2 + 4x + 2) - (x^2 + 2x + 1)$
11. $(3x^2 + x + 2) - (-4x^2 + 3x - 1)$
12. $(4x^2 - 2x + 7) - (-5x^2 + 4x - 8)$
13. $(-x^2 - 3x - 6) - (7x^2 - 4x + 7)$
14. $(-3x^2 - x + 6) - (-2x^2 - x - 7)$
15. $(4x^2 + x) - (6x^2 - x + 2)$
16. $(-3x + 9) - (5x^2 - 6x - 1)$
17. $(3y^2 + x - 4) + (-x^2 + x - 3)$
18. $(5y^2 + 3x^2 + x - y) - (-2y^2 + y)$
19. $(x^3 + y^2 - y) - (y^2 + x)$
20. $(-3x^3 + 2x^2 + x) + (-x^2 + y)$

Answers

1. $2x^2 + 7x + 7$
2. $7x^2 + 3x + 10$
3. $2x^2 + 6x + 3$
4. $3x^2 + 3x + 16$
5. $3x^2 + 2x - 1$
6. $x^2 - x - 2$
7. $-2x^2 - 9x + 3$
8. $-2x$
9. $4x^2 + x - 10$
10. $2x^2 + 2x + 1$
11. $7x^2 - 2x + 3$
12. $9x^2 - 6x + 15$
13. $-8x^2 + x - 13$
14. $-x^2 + 13$
15. $-2x^2 + 2x - 2$
16. $-5x^2 + 3x + 10$
17. $3y^2 - x^2 + 2x - 7$
18. $7y^2 + 3x^2 + x - 2y$
19. $x^3 - y - x$
20. $-3x^3 + x^2 + x + y$

ORDER OF OPERATIONS

#3

The **order of operations** establishes the necessary rules so that expressions are evaluated in a consistent way by everyone. The rules, in order, are:

- When grouping symbols such as parentheses are present, do the operations within them first.
- Next, perform all operations with exponents.
- Then do multiplication and division in order from left to right.
- Finally, do addition and subtraction in order from left to right.

Also see the textbook, page 49.

Example

Simplify the numerical expression at right:

$$12 \div 2^2 - 4 + 3(1 + 2)^3$$

Start by simplifying the parentheses: $3(1 + 2)^3 = 3(3)^3$

so $12 \div 2^2 - 4 + 3(3)^3$

Then perform the exponent operation: $2^2 = 4$ and $3^3 = 27$

so $12 \div 4 - 4 + 3(27)$

Next, multiply and divide left to right: $12 \div 4 = 3$ and $3(27) = 81$

so $3 - 4 + 81$

Finally, add and subtract left to right: $3 - 4 = -1$

so $-1 + 81 = 80$

Simplify the following numerical expressions.

1. $29 + 16 \div 8 \cdot 25$

2. $36 + 16 - 50 \div 25$

3. $2(3 - 1) \div 8$

4. $\frac{1}{2}(6 - 2)^2 - 4 \cdot 3$

5. $3[2(1 + 5) + 8 - 3^2]$

6. $(8 + 12) \div 4 - 6$

7. $-6^2 + 4 \cdot 8$

8. $18 \cdot 3 \div 3^3$

9. $10 + 5^2 - 25$

10. $20 - (3^3 \div 9) \cdot 2$

11. $100 - (2^3 - 6) \div 2$

12. $22 + (3 \cdot 2)^2 \div 2$

13. $85 - (4 \cdot 2)^2 - 3$

14. $12 + 3\left(\frac{8-2}{12-9}\right) - 2\left(\frac{9-1}{19-15}\right)$

15. $15 + 4\left(\frac{11-2}{9-6}\right) - 2\left(\frac{12-4}{18-10}\right)$

Answers

1. 79

2. 50

3. $\frac{1}{2}$

4. -4

5. 33

6. -1

7. -4

8. 2

9. 10

10. 14

11. 99

12. 40

13. 18

14. 14

15. 25

DISTRIBUTIVE PROPERTY

#4

The **Distributive Property** is used to regroup a numerical expression or a polynomial with two or more terms by multiplying each value or term of the polynomial. The resulting sum is an equivalent numerical or algebraic expression. Also see the textbook, page 198. In general, the Distributive Property is expressed as:

$$a(b + c) = ab + ac \text{ and } (b + c)a = ba + ca$$

Example 1

$$2(x+4) = (2 \cdot x) + (2 \cdot 4) = 2x + 8$$

Example 2

$$(x + 2y + 1)2 = (2 \cdot x) + (2 \cdot 2y) + 2(1) = 2x + 4y + 2$$

Simplify each expression below by applying the Distributive Property. Follow the correct order of operations in problems 18 through 22.

1. $3(1+5)$

2. $4(3+2)$

3. $2(x+6)$

4. $5(x+4)$

5. $3(x-4)$

6. $6(x-6)$

7. $(3+x)4$

8. $(2+x)2$

9. $-x(3-1)$

10. $-4(x-1)$

11. $x(y-z)$

12. $a(b-c)$

13. $3(x+y+3)$

14. $5(y+2x+3)$

15. $2(-x+y-3)$

16. $-4(3x-y+2)$

17. $x(x+3x)$

18. $4(x+2^2+x^2)$

19. $(2x^2-5x-7)3$

20. $(a+b-c)d$

21. $5a\left(\frac{12-3}{3} + 2\left(\frac{1}{2} + \frac{1}{2}\right) - b^2\right)$

22. $b\left(2^2 + \frac{1}{3}(6+3) - ab\right)$

Answers

1. $(3 \cdot 1) + (3 \cdot 5)$ or $3(6) = 18$

2. $(4 \cdot 3) + (4 \cdot 2)$ or $4(5) = 20$

3. $2x + 12$

4. $5x + 20$

5. $3x - 12$

6. $6x - 36$

7. $12 + 4x$

8. $4 + 2x$

9. $-3x + x = -2x$

10. $-4x + 4$

11. $xy - xz$

12. $ab - ac$

13. $3x + 3y + 9$

14. $5y + 10x + 15$

15. $-2x + 2y - 6$

16. $-12x + 4y - 8$

17. $x^2 + 3x^2 = 4x^2$

18. $4x^2 + 4x + 16$

19. $6x^2 - 15x - 21$

20. $ad + bd - cd$

21. $25a - 5ab^2$

22. $7b - ab^2$

SUBSTITUTION AND EVALUATION

#5

Substitution is replacing one symbol with another (a number, a variable, or an expression). One application of the substitution property is replacing a variable name with a number in any expression or equation. In general, if $a = b$, then a may replace b and b may replace a . A **variable** is a letter used to represent one or more numbers (or other algebraic expressions). The numbers are the values of the variable. A variable expression has numbers and variables and operations performed on it. Also see the textbook, pages 43, 46, and 49.

Examples

Evaluate each variable expression for $x = 2$.

a) $5x \Rightarrow 5(2) \Rightarrow 10$

b) $x + 10 \Rightarrow (2) + 10 \Rightarrow 12$

c) $\frac{18}{x} \Rightarrow \frac{18}{(2)} \Rightarrow 9$

d) $\frac{x}{2} \Rightarrow \frac{2}{2} \Rightarrow 1$

e) $3x - 5 \Rightarrow 3(2) - 5 \Rightarrow 6 - 5 \Rightarrow 1$

f) $5x + 3x \Rightarrow 5(2) + 3(2) \Rightarrow 10 + 6 \Rightarrow 16$

Evaluate each of the variable expressions below for the values $x = -3$ and $y = 2$. Be sure to follow the order of operations as you simplify each expression.

1. $x + 3$

2. $x - 2$

3. $x + y + 4$

4. $y - 2 + x$

5. $x^2 - 7$

6. $-x^2 + 4$

7. $x^2 + 2x - 1$

8. $-2x^2 + 3x$

9. $x + 2 + 3y$

10. $y^2 + 2x - 1$

11. $x^2 + y^2 + 2^2$

12. $3^2 + y^2 - x^2$

Evaluate the expressions below using the values of the variables in each problem. These problems ask you to evaluate each expression twice, once with each of the values.

13. $2x^2 - 3x + 4$ for $x = -2$ and $x = 5$

14. $-4x^2 + 8$ for $x = -2$ and $x = 5$

15. $3x^2 - 2x + 8$ for $x = -3$ and $x = 3$

16. $-x^2 + 3$ for $x = -3$ and $x = 3$

Evaluate the variable expressions for $x = -4$ and $y = 5$.

17. $x(x + 3x)$

18. $2(x + 4x)$

19. $2(x + y) + 4\left(\frac{y+3}{x}\right)$

20. $4\left(y^2 + 2\left(\frac{x+9}{5}\right)\right)$

21. $3y(x + x^2 - y)$

22. $(x + y)(3x + 4y)$

Answers

1. 0

2. -5

3. 3

4. -3

5. 2

6. -5

7. 2

8. -27

9. 5

10. -3

11. 17

12. 4

13. a) 18 b) 39

14. a) -8 b) -92

15. a) 41 b) 29

16. a) -6 b) -6

17. 64

18. -40

19. -6

20. 108

21. 105

22. 8

TABLES, EQUATIONS, AND GRAPHS

#6

An input/output table provides the opportunity to find the rule that determines the output value for each input value. If you already know the rule, the table is one way to find points to graph the equation, which in this course will usually be written in y-form as $y = mx + b$. Also see the textbook, page 161.

Example 1

Use the input/output table below to find the pattern (rule) that pairs each x-value with its y-value. Write the rule below x in the table, then write the equation in y-form.

x (input)	-1	3	2	-3	1	0	-4	4	-2	x
y (output)		5			1	-1		7	-5	

Use a guess and check approach to test various patterns. Since $(3, 5)$ is in the table, try $y = x + 2$ and test another input value, $x = 1$, to see if the same rule works. Unfortunately, this is not true. Next try $2x$ and add or subtract values. For $(4, 7)$, $2(4) - 1 = 7$. Now try $(-2, -5)$: $2(-2) - 1 = -5$. Test $(3, 5)$: $2(3) - 1 = 5$. It appears that the equation for this table is $y = 2x - 1$.

Example 2

Find the missing values for $y = 2x + 1$ and graph the equation. Each output value is found by substituting the input value for x , multiplying it by 2, then adding 1.

x (input)	-3	-2	-1	0	1	2	3	4	5	x
y (output)	-5				3		7			$2x+1$

- x-values are referred to as inputs. The set of all input values is the domain.
- y-values are referred to as outputs. The set of all output values is the range.

Use the pairs of input/output values in the table to graph the equation. A portion of the graph is shown at right.

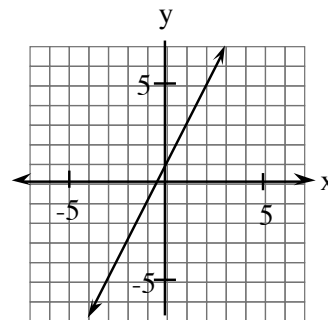

For each input/output table below, find the missing values, write the rule for x , then write the equation in y -form.

1.

input x	-3	-2	-1	0	1	2	3	x
output y			-1	1			7	

2.

input x	-3	-2	-1	0	1	2	3	x
output y	0		2			5		

3.

input x	-3	-2	-1	0	1	2	3	x
output y		-4		-2		0		

4.

input x	-3	-2	-1	0	1	2	3	x
output y	-10			-1			8	

5.

input x	2	7		-3		-4	3	x
output y	10		8	-10	22			

6.

input x	0	5		-6		3	7	x
output y	3		1	-9	-1	9		-5

7.

input x	4	3	-2	0	1	-5	-1	x
output y		-11		-5			-3	

8.

input x	6		0	7		-2	-1	x
output y		-6	-3		2		-4	1

9.

input x	$-\frac{1}{2}$	0	0.3	0.5	0.75	$\frac{5}{4}$	3.2	x
output y	0		0.8			$\frac{7}{4}$		

10.

input x	$-\frac{3}{4}$	$-\frac{1}{2}$	$-\frac{1}{4}$	0	$\frac{1}{4}$	$\frac{1}{2}$	$\frac{3}{4}$	1	x
output y		$-\frac{1}{4}$		0			$\frac{3}{8}$		

11.

input x	-3	-2	-1	0	1	2	3	x
output y		5		3		1		

12.

input x	-3	-2	-1	0	1	2	3	4	x
output y		2		-2		-6			

13.

input x	5	-2		0		4		x
output y		5	-21	-3	13		9	

14.

input x	5	6	-3		7	4		2	x
output y	2		10	16			1	5	

15.

input x	-3	-2	-1	0	1	2	3	x
output y		4		0			9	

16.

input x	-3	-2	-1	0	1	2	3	x
output y	10		2			5		

Make an input/output table and use it to draw a graph for each of the following equations. Use inputs (domain values) of $-3 \leq x \leq 3$.

17. $y = x + 5$

18. $y = -x + 4$

19. $y = 2x + 3$

20. $y = \frac{1}{2}x - 2$

21. $y = -\frac{2}{3}x + 3$

22. $y = 2$

23. $y = x^2 + 3$

24. $y = -x^2 - 4$

Answers

1. $y = 2x + 1$

input x	-3	-2	-1	0	1	2	3	x
output y	-5	-3	-1	1	3	5	7	$2x+1$

2. $y = x + 3$

input x	-3	-2	-1	0	1	2	3	x
output y	0	1	2	3	4	5	6	$x+3$

3. $y = x - 2$

input x	-3	-2	-1	0	1	2	3	x
output y	-5	-4	-3	-2	-1	0	1	$x-2$

4. $y = 3x - 1$

input x	-3	-2	-1	0	1	2	3	x
output y	-10	-7	-4	-1	2	5	8	$3x-1$

5. $y = 4x + 2$

input x	2	7	$\frac{3}{2}$	-3	5	-4	3	x
output y	10	30	8	-10	22	-14	14	$4x+2$

6. $y = 2x + 3$

input x	0	5	-1	-6	-2	3	7	-4	x
output y	3	13	1	-9	-1	9	17	-5	$2x+3$

7. $y = -2x - 5$

input x	4	3	-2	0	1	-5	-1	x
output y	-13	-11	-1	-5	-7	5	-3	$-2x-5$

8. $y = x - 3$

input x	6	-3	0	7	5	-2	-1	4	x
output y	3	-6	-3	4	2	-5	-4	1	$x-3$

9. $y = x + 0.5$

input x	$-\frac{1}{2}$	0	0.3	0.5	0.75	$\frac{5}{4}$	3.2	x
output y	0	0.5	0.8	1	1.25	$\frac{7}{4}$	3.7	$x+0.5$

10. $y = \frac{1}{2}x$

input x	$-\frac{3}{4}$	$-\frac{1}{2}$	$-\frac{1}{4}$	0	$\frac{1}{4}$	$\frac{1}{2}$	$\frac{3}{4}$	1	x
output y	$-\frac{3}{8}$	$-\frac{1}{4}$	$-\frac{1}{8}$	0	$\frac{1}{8}$	$\frac{1}{4}$	$\frac{3}{8}$	$\frac{1}{2}$	$\frac{1}{2}x$

11.

input x	-3	-2	-1	0	1	2	3	x
output y	6	5	4	3	2	1	0	$-x+3$

12.

input x	-3	-2	-1	0	1	2	3	4	x
output y	4	2	0	-2	-4	-6	-8	-10	$-2x-2$

13.

input x	5	-2	4.5	0	-4	4	-3	x
output y	-23	5	-21	-3	13	-19	9	$-4x-3$

14.

input x	5	6	-3	-9	7	4	6	2	x
output y	2	1	10	16	0	3	1	5	$-x+7$

15.

input x	-3	-2	-1	0	1	2	3	x
output y	9	4	1	0	1	4	9	x^2

16.

input x	-3	-2	-1	0	1	2	3	x
output y	10	5	2	1	2	5	10	x^2+1

17.

input x	-3	-2	-1	0	1	2	3
output y	2	3	4	5	6	7	8

18.

input x	-3	-2	-1	0	1	2	3
output y	7	6	5	4	3	2	1

19.

input x	-3	-2	-1	0	1	2	3
output y	-3	-1	1	3	5	7	9

20.

input x	-3	-2	-1	0	1	2	3
output y	-3.5	-3	-2.5	-2	-1.5	-1	-0.5

21.

input x	-3	-2	-1	0	1	2	3
output y	5	$4\frac{1}{3}$	$3\frac{2}{3}$	3	$2\frac{1}{3}$	$1\frac{2}{3}$	1

22.

input x	-3	-2	-1	0	1	2	3
output y	2	2	2	2	2	2	2

23.

input x	-3	-2	-1	0	1	2	3
output y	12	7	4	3	4	7	12

24.

input x	-3	-2	-1	0	1	2	3
output y	-13	-8	-5	-4	-5	-8	-13

17.

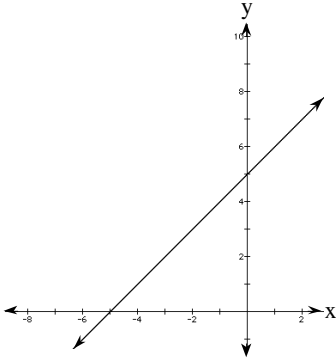

18.

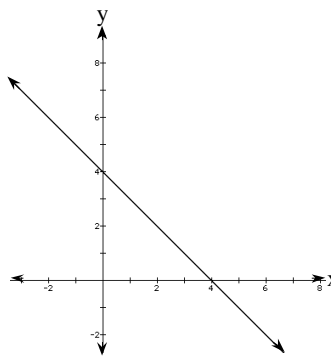

19.

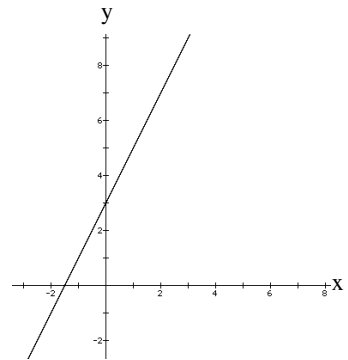

20.

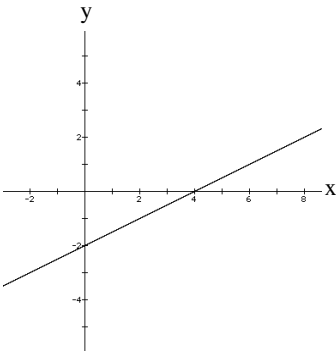

21.

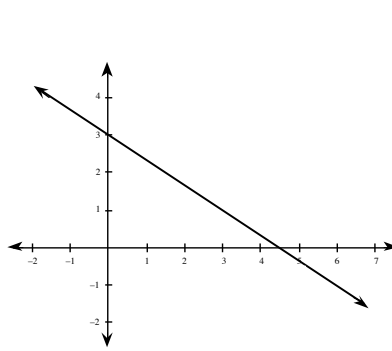

22.

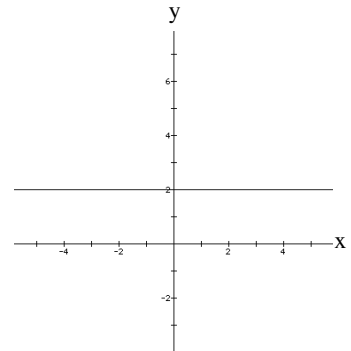

23.

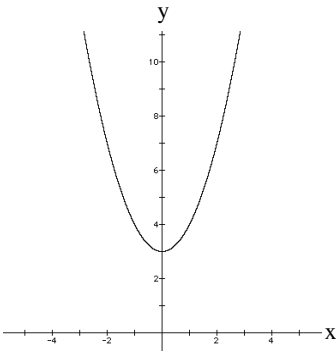

24.

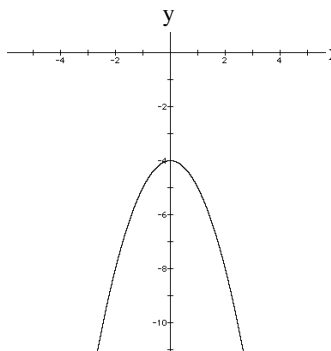

SOLVING LINEAR EQUATIONS

#7

Solving equations involves “undoing” what has been done to create the equation. In this sense, solving an equation can be described as “working backward,” generally known as using inverse (or opposite) operations. For example, to undo $x + 2 = 5$, that is, adding 2 to x , subtract 2 from both sides of the equation. The result is $x = 3$, which makes $x + 2 = 5$ true. For $2x = 17$, x is multiplied by 2, so divide both sides by 2 and the result is $x = 8.5$. For equations like those in the examples and exercises below, apply the idea of inverse (opposite) operations several times. Always follow the correct order of operations. Also see the textbook, pages 171 and 201.

Example 1

$$\text{Solve for } x: 2(2x - 1) - 6 = -x + 2$$

First distribute to remove the parentheses, then combine like terms.

$$\begin{aligned} 4x - 2 - 6 &= -x + 2 \\ 4x - 8 &= -x + 2 \end{aligned}$$

Next, move variables and constants by addition of opposites to get the variable term on one side of the equation.

$$\begin{array}{r} 4x - 8 = -x + 2 \\ +x \quad +x \\ \hline 5x - 8 = \quad 2 \end{array}$$

$$\begin{array}{r} 5x - 8 = 2 \\ +8 \quad +8 \\ \hline 5x = 10 \end{array}$$

Now, divide by 5 to get the value of x .

$$\frac{5x}{5} = \frac{10}{5} \Rightarrow x = 2$$

Finally, check that your answer is correct.

$$\begin{aligned} 2(2(2) - 1) - 6 &= -(2) + 2 \\ 2(4 - 1) - 6 &= 0 \\ 2(3) - 6 &= 0 \\ 6 - 6 &= 0 \text{ checks} \end{aligned}$$

Example 2

$$\text{Solve for } y: 2x + 3y - 9 = 0$$

This equation has two variables, but the instruction says to isolate y . First move the terms without y to the other side of the equation by adding their opposites to both sides of the equation.

$$\begin{array}{r} 2x + 3y - 9 = 0 \\ +9 \quad +9 \\ \hline 2x + 3y = +9 \end{array}$$

$$2x + 3y = +9$$

$$\begin{array}{r} 2x + 3y = \quad 9 \\ -2x \quad -2x \\ \hline 3y = -2x + 9 \end{array}$$

Divide by 3 to isolate y . Be careful to divide every term on the right by 3.

$$\frac{3y}{3} = \frac{-2x+9}{3} \Rightarrow y = -\frac{2}{3}x + 3$$

Solve each equation below.

- | | | |
|-----------------------------------|-------------------------------------|----------------------------|
| 1. $5x + 2 = -x + 14$ | 2. $3x - 2 = x + 10$ | 3. $6x + 4x - 2 = 15$ |
| 4. $6x - 3x + 2 = -10$ | 5. $\frac{2}{3}y - 6 = 12$ | 6. $\frac{3}{4}x + 2 = -7$ |
| 7. $2(x + 2) = 3(x - 5)$ | 8. $3(m - 2) = -2(m - 7)$ | |
| 9. $3(2x + 2) + 2(x - 7) = x + 3$ | 10. $2(x + 3) + 5(x - 2) = -x + 10$ | |
| 11. $4 - 6(w + 2) = 10$ | 12. $6 - 2(x - 3) = 12$ | |
| 13. $3(2z - 7) = 5z + 17 + z$ | 14. $-3(2z - 7) = -3z + 21 - 3z$ | |

Solve for the named variable.

- | | | |
|---------------------------------|-----------------------------|------------------------------|
| 15. $2x + b = c$ (for x) | 16. $3x - d = m$ (for x) | 17. $3x + 2y = 6$ (for y) |
| 18. $-3x + 5y = -10$ (for y) | 19. $y = mx + b$ (for b) | 20. $y = mx + b$ (for x) |

Answers

- | | | | |
|-----------------------------|----------------------------|-------------------------|-------------------------|
| 1. 2 | 2. 6 | 3. $\frac{17}{10}$ | 4. -4 |
| 5. 27 | 6. -12 | 7. 19 | 8. 4 |
| 9. $\frac{11}{7}$ | 10. $\frac{7}{4}$ | 11. -3 | 12. 0 |
| 13. no solution | 14. all numbers | 15. $x = \frac{c-b}{2}$ | 16. $x = \frac{m+d}{3}$ |
| 17. $y = -\frac{3}{2}x + 3$ | 18. $y = \frac{3}{5}x - 2$ | 19. $b = y - mx$ | 20. $x = \frac{y-b}{m}$ |

WRITING EQUATIONS

#8

To use a Guess and Check table to write an equation, set up the table headings, make several guesses and test them to establish the pattern of the relationship in the problem, then write the equation using the pattern in the table. Another strategy is to define the variable(s), write mathematical sentences based on the information, and then solve the equation(s). Also see the textbook, pages 65 and 232-34.

Example 1 (using Guess and Check)

The perimeter of a triangle is 51 centimeters. The longest side is twice the length of the shortest side. The third side is three centimeters longer than the shortest side. How long is each side? Write an equation that represents the problem.

First set up a table (with headings) for this problem and, if necessary, fill in numbers to see the pattern.

guess short side	long side	third side	perimeter	check 51?
10	$2(10) = 20$	$10 + 3 = 13$	$10 + 20 + 13 = 43$	too low
15	$2(15) = 30$	$15 + 3 = 18$	$15 + 30 + 18 = 63$	too high
13	$2(13) = 26$	$13 + 3 = 16$	$13 + 26 + 16 = 55$	too high
12	$2(12) = 24$	$12 + 3 = 15$	$12 + 24 + 15 = 51$	correct

The lengths of the sides are 12 cm, 24 cm, and 15 cm.

Since we could guess any number for the short side, use x to represent it and continue the pattern.

guess short side	long side	third side	perimeter	check 51?
x	$2x$	$x + 3$	$x + 2x + x + 3$	51

A possible equation is $x + 2x + x + 3 = 51$ (simplified, $4x + 3 = 51$). Solving the equation gives the same solution as the Guess and Check table.

Example 2 (using Guess and Check)

Darren sold 75 tickets worth \$462.50 for the school play. He charged \$7.50 for adults and \$3.50 for students. How many of each kind of ticket did he sell? First set up a table with columns and headings for number of tickets and their value.

guess number of adult tickets sold	value of adult tickets sold	number of student tickets sold	value of student tickets sold	total value	check 462.50?
40	$40(7.50) = 300$	$75 - 40 = 35$	$3.50(35) = 122.50$	$300 + 122.50 = 422.50$	too low

By guessing different (and in this case, larger) numbers of adult tickets, the answer can be found. The pattern from the table can be generalized as an equation.

number of adult tickets sold	value of adult tickets sold	number of student tickets sold	value of student tickets sold	total value	check 462.50?
x	7.50x	75 - x	3.50(75 - x)	7.50x + 3.50(75 - x)	462.50

A possible equation is $7.50x + 3.50(75 - x) = 462.50$. Solving the equation gives the solution--50 adult tickets and 25 student tickets--without guessing and checking.

$$7.50x + 3.50(75 - x) = 462.50 \Rightarrow 7.50x + 262.50 - 3.50x = 462.50$$

$$\Rightarrow 4x = 200 \Rightarrow x = 50 \text{ adult tickets} \Rightarrow 75 - x = 75 - 50 = 25 \text{ student tickets}$$

Example 2 (defining variables and writing equations)

Let a = the number of adults; s = the number of students

Since 75 tickets were sold $\Rightarrow a + s = 75$

Since adult tickets cost 7.50, $7.50a$ is the adult revenue. Similarly $3.50s$ is the student revenue and \$462.50 is the total revenue

$$\Rightarrow 7.50a + 3.50s = 462.50$$

Solving the first equations for s ($s = 75 - a$) and replacing or substituting it in the second equation yields the same equation as the Guess and Check method and is solved in the same way.

Write a possible equation and find the solution. Define your variables using a Guess and Check table or a "let" statement.

1. A box of fruit has four more apples than oranges. Together there are 52 pieces of fruit. How many of each type of fruit are there?
2. Thu and Cleo are sharing the driving on a 520 mile trip. If Thu drives 60 miles more than Cleo, how far did each of them drive?
3. Aimee cut a string that was originally 126 centimeters long into two pieces so that one piece is twice as long as the other. How long is each piece?
4. A full bucket of water weighs eight kilograms. If the water weighs five times as much as the empty bucket, how much does the water weigh?
5. The perimeter of a rectangle is 100 feet. If the length is five feet more than twice the width, find the length and width.

6. The perimeter of a rectangular city is 94 miles. If the length is one mile less than three times the width, find the length and width of the city.
7. Find three consecutive numbers whose sum is 138.
8. Find three consecutive even numbers whose sum is 468.
9. The perimeter of a triangle is 57. The first side is twice the length of the second side. The third side is seven more than the second side. What is the length of each side?
10. The perimeter of a triangle is 86 inches. The largest side is four inches less than twice the smallest side. The third side is 10 inches longer than the smallest side. What is the length of each side?
11. Thirty more student tickets than adult tickets were sold for the game. Student tickets cost \$2, adult tickets cost \$5, and \$1460 was collected. How many of each kind of ticket were sold?
12. Fifty more "couples" tickets than "singles" tickets were sold for the dance. "Singles" tickets cost \$10 and "couples" tickets cost \$15. If \$4000 was collected, how many of each kind of ticket was sold?
13. Helen has twice as many dimes as nickels and five more quarters than nickels. The value of her coins is \$4.75. How many dimes does she have?
14. Ly has three more dimes than nickels and twice as many quarters as dimes. The value of his coins is \$9.60. How many of each kind of coin does he have?
15. Enrique put his money in the credit union for one year. His money earned 8% simple interest and at the end of the year his account was worth \$1350. How much was originally invested?
16. Juli's bank pays 7.5% simple interest. At the end of the year, her college fund was worth \$10,965. How much was it worth at the start of the year?
17. Elisa sold 110 tickets for the football game. Adult tickets cost \$2.50 and student tickets cost \$1.10. If she collected \$212, how many of each kind of ticket did she sell?
18. The first performance of the school play sold out all 2000 tickets. The ticket sales receipts totaled \$8500. If adults paid \$5 and students paid \$3 for their tickets, how many of each kind of ticket was sold?
19. Leon and Jason leave Los Angeles going in opposite directions. Leon travels five miles per hour faster than Jason. In four hours they are 524 miles apart. How fast is each person traveling?
20. Keri and Yuki leave New York City going in opposite directions. Keri travels three miles per hour slower than Yuki. In six hours they are 522 miles apart. How fast is each person traveling?

Answers (equations may vary)

1. 24 oranges, 28 apples; $x + (x + 4) = 52$, x = oranges
2. Cleo 230 miles, Thu 290 miles; $x + (x + 60) = 520$, x = Cleo
3. 42, 84; $x + 2x = 126$, x = short piece
4. $6\frac{2}{3}$ kg.; $x + 5x = 8$, x = weight of bucket
5. 15, 35; $2x + 2(2x + 5) = 100$, x = width
6. 12, 35; $2x + 2(3x - 1) = 94$, x = width
7. 45, 46, 47; $x + (x + 1) + (x + 2) = 138$
 x = first number
8. 154, 156, 158; $x + (x + 2) + (x + 4) = 468$
 x = first number
9. 25, 12.5, 19.5; $x + 2x + (x + 7) = 57$
 x = second side
10. 20, 36, 30; $x + (2x - 4) + (x + 10) = 86$
 x = smallest side
11. 200 adult, 230 students; $5x + 2(x + 30) = 1460$, x = adult tickets
12. 130 single, 180 couple; $10x + 15(x + 50) = 4000$, x = "singles" tickets
13. 7 nickels, 14 dimes, 12 quarters; $0.05x + 0.10(2x) + 0.25(x + 5) = 4.75$, x = nickels
14. 12 nickels, 15 dimes, 30 quarters; $0.05x + 0.10(x + 3) + 0.25(2x + 6) = 9.60$, x = nickels
15. \$1250; $x + 0.08x = 1350$
 x = amount invested
16. 10,200; $x + 0.075x = 10,965$
 x = original value of her fund
17. 65 adult, 45 student; $2.50x + 1.10(110 - x) = 212$, x = adult tickets
18. 1250 adults, 750 students; $5.00x + 3.00(2000 - x) = 8500$, x = adult tickets
19. Jason 63, Leon 68; $4x + 4(x + 5) = 524$, x = Jason's speed
20. Yuki 45, Keri 42; $6x + 6(x - 3) = 522$, x = Yuki's speed

SOLVING PROPORTIONS

#9

A **proportion** is an equation stating that two ratios (fractions) are equal. To solve a proportion, begin by eliminating fractions. This means using the inverse operation of division, namely, multiplication. Multiply both sides of the proportion by one or both of the denominators. Then solve the resulting equation in the usual way. Also see the textbook, pages 209-11.

Example 1

$$\frac{x}{3} = \frac{5}{8}$$

Undo the division by 3 by multiplying both sides by 3.

$$(3)\frac{x}{3} = \frac{5}{8}(3)$$

$$x = \frac{15}{8} = 1\frac{7}{8}$$

Example 2

$$\frac{x}{x+1} = \frac{3}{5}$$

Multiply by 5 and $(x+1)$ on both sides of the equation.

$$5(x+1)\frac{x}{x+1} = \frac{3}{5}(5)(x+1)$$

Note that $\frac{(x+1)}{(x+1)} = 1$ and $\frac{5}{5} = 1$, so $5x = 3(x+1)$

$$5x = 3x + 3 \Rightarrow 2x = 3 \Rightarrow x = \frac{3}{2} = 1\frac{1}{2}$$

Solve for x or y .

1. $\frac{2}{5} = \frac{y}{15}$

2. $\frac{x}{36} = \frac{4}{9}$

3. $\frac{2}{3} = \frac{x}{5}$

4. $\frac{5}{8} = \frac{x}{100}$

5. $\frac{3x}{10} = \frac{24}{9}$

6. $\frac{3y}{5} = \frac{24}{10}$

7. $\frac{x+2}{3} = \frac{5}{7}$

8. $\frac{x-1}{4} = \frac{7}{8}$

9. $\frac{4x}{5} = \frac{x-2}{7}$

10. $\frac{3x}{4} = \frac{x+1}{6}$

11. $\frac{9-x}{6} = \frac{24}{2}$

12. $\frac{7-y}{5} = \frac{3}{4}$

13. $\frac{1}{x} = \frac{5}{x+1}$

14. $\frac{3}{y} = \frac{6}{y-2}$

15. $\frac{4}{x} = \frac{x}{9}$

16. $\frac{25}{y} = \frac{y}{4}$

Answers

1. 6 2. 16 3. $\frac{10}{3} = 3\frac{1}{3}$ 4. $62\frac{1}{2}$ 5. $\frac{80}{9}$ 6. 4
7. $\frac{1}{7}$ 8. $4\frac{1}{2}$ 9. $-\frac{10}{23}$ 10. $\frac{2}{7}$ 11. -63 12. $\frac{13}{4}$
13. $\frac{1}{4}$ 14. -2 15. ± 6 16. ± 10

PROPORTIONAL REASONING: RATIO APPLICATIONS

#10

Ratios and proportions are used to solve problems involving similar figures, percents, and relationships that vary directly.

Example 1

$\triangle ABC$ is similar to $\triangle DEF$. Use ratios to find x .

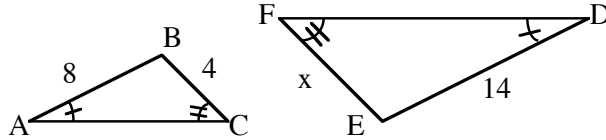

Since the triangles are similar, the ratios of the corresponding sides are equal.

$$\frac{8}{14} = \frac{4}{x} \Rightarrow 8x = 56 \Rightarrow x = 7$$

Example 2

- What percent of 60 is 45?
- Forty percent of what number is 45?

In percent problems use the following proportion: $\frac{\text{part}}{\text{whole}} = \frac{\text{percent}}{100}$.

- $\frac{45}{60} = \frac{x}{100}$
 $60x = 4500$
 $x = 75$ (75%)
- $\frac{40}{100} = \frac{45}{x}$
 $40x = 4500$
 $x = 112$

Example 3

Amy usually swims 20 laps in 30 minutes. How long will it take to swim 50 laps at the same rate?

Since two units are being compared, set up a ratio using the unit words consistently. In this case, “laps” is on top (the numerator) and “minutes” is on the bottom (the denominator) in both ratios. Then solve as shown in Skill Builder #9.

$$\frac{\text{laps}}{\text{minutes}} : \frac{20}{30} = \frac{50}{x} \Rightarrow 20x = 1500 \Rightarrow x = 75 \text{ minutes}$$

Each pair of figures is similar. Solve for the variable.

1.

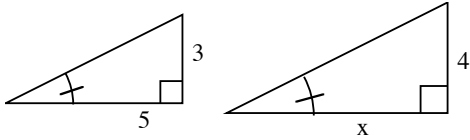

2.

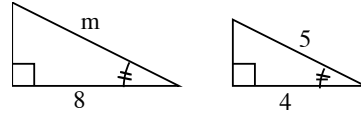

3.

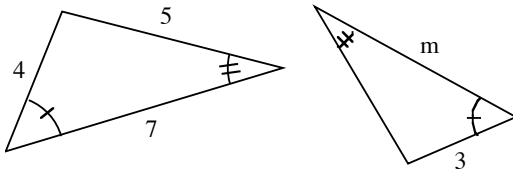

4.

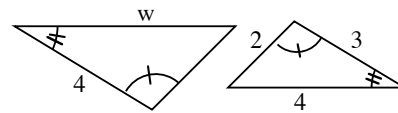

5.

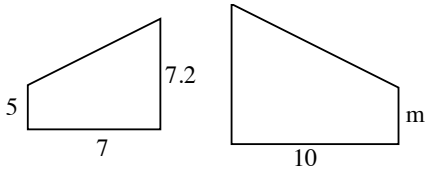

6.

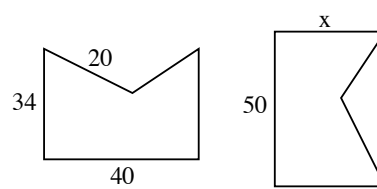

7.

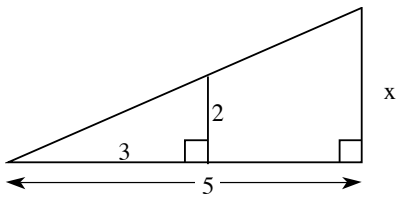

8.

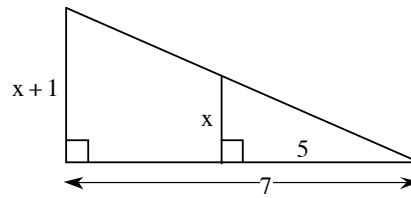

Write and solve a proportion to find the missing part.

- | | |
|-------------------------------|---------------------------------|
| 9. 15 is 25% of what? | 10. 12 is 30% of what? |
| 11. 45% of 200 is what? | 12. 32% of 150 is what? |
| 13. 18 is what percent of 24? | 14. What percent of 300 is 250? |
| 15. What is 32% of \$12.50? | 16. What is 7.5% of \$325.75? |

Use ratios to solve each problem.

17. A rectangle has length 10 feet and width six feet. It is enlarged to a similar rectangle with length 18 feet. What is the new width?
18. If 200 vitamins cost \$4.75, what should 500 vitamins cost?

19. The tax on a \$400 painting is \$34. What should the tax be on a \$700 painting?
20. If a basketball player made 72 of 85 free throws, how many free throws could she expect to make in 200 attempts?
21. A cookie recipe uses $\frac{1}{2}$ teaspoon of vanilla with $\frac{3}{4}$ cup of flour. How much vanilla should be used with five cups of flour?
22. My brother grew $1\frac{3}{4}$ inches in $2\frac{1}{2}$ months. At that rate, how much would he grow in one year?
23. The length of a rectangle is four centimeters more than the width. If the ratio of the length to width is seven to five, find the dimensions of the rectangle.
24. A class has three fewer girls than boys. If the ratio of girls to boys is four to five, how many students are in the class?

Answers

- | | | | |
|----------------------------------|---------------------------|----------------------------------|----------------------------------|
| 1. $\frac{20}{3} = 6\frac{2}{3}$ | 2. 10 | 3. $5\frac{1}{4}$ | 4. $\frac{16}{3} = 5\frac{1}{3}$ |
| 5. $\frac{50}{7} = 7\frac{1}{7}$ | 6. 42.5 | 7. $\frac{10}{3} = 3\frac{1}{3}$ | 8. $2\frac{1}{2}$ |
| 9. 60 | 10. 40 | 11. 90 | 12. 48 |
| 13. 75% | 14. $83\frac{1}{3}\%$ | 15. \$4 | 16. \$24.43 |
| 17. 10.8 ft. | 18. \$11.88 | 19. \$59.50 | 20. About 169 shots |
| 21. $3\frac{1}{3}$ teaspoons | 22. $8\frac{2}{5}$ inches | 23. 10 cm x 14 cm | 24. 27 students |

USING EQUAL VALUES METHOD OR SUBSTITUTION TO FIND THE POINT OF INTERSECTION OF TWO LINES

#11

To find where two lines intersect we could graph them, but there is a faster, more accurate algebraic method called the **equal values method** or **substitution method**. This method may also be used to solve systems of equations in word problems. Also see the textbook, pages 169-70, 173-76, 242-43, and 248

Example 1

Start with two linear equations in y-form.

$$y = -2x + 5 \quad \text{and} \quad y = x - 1$$

Substitute the equal parts.

$$-2x + 5 = x - 1$$

Solve for x .

$$6 = 3x \quad \Rightarrow \quad x = 2$$

The x -coordinate of the point of intersection is $x = 2$. To find the y -coordinate, substitute the value of x into either original equation. Solve for y , then write the solution as an ordered pair. Check that the point works in both equations.

$$y = -2(2) + 5 = 1 \quad \text{and} \quad y = 2 - 1 = 1, \text{ so } (2, 1) \text{ is where the lines intersect.}$$

$$\text{Check: } 1 = -2(2) + 5 \quad \checkmark \quad \text{and} \quad 1 = 2 - 1 \quad \checkmark.$$

Example 2

The sales of Gizmo Sports Drink at the local supermarket are currently 6,500 bottles per month. Since New Age Refreshers were introduced, sales of Gizmo have been declining by 55 bottles per month. New Age currently sells 2,200 bottles per month and its sales are increasing by 250 bottles per month. If these rates of change remain the same, in about how many months will the sales for both companies be the same? How many bottles will each company be selling at that time?

Let x = months from now and y = total monthly sales.

$$\text{For Gizmo: } y = 6500 - 55x; \quad \text{for New Age: } y = 2200 + 250x.$$

$$\text{Substituting equal parts: } 6500 - 55x = 2200 + 250x \quad \Rightarrow \quad 4300 = 305x \quad \Rightarrow \quad 14.10 \approx x.$$

Use either equation to find y :

$$y = 2200 + 250(14.10) \approx 5725 \quad \text{and} \quad y = 6500 - 55(14.10) \approx 5725.$$

The solution is $(14.10, 5725)$. This means that in about 14 months, both drink companies will be selling 5,725 bottles of the sports drinks.

Find the point of intersection (x, y) for each pair of lines by using the equal values method.

- | | | | |
|---|--|-----------------------------------|---------------------------------|
| 1. $y = x + 2$
$y = 2x - 1$ | 2. $y = 3x + 5$
$y = 4x + 8$ | 3. $y = 11 - 2x$
$y = x + 2$ | 4. $y = 3 - 2x$
$y = 1 + 2x$ |
| 5. $y = 3x - 4$
$y = \frac{1}{2}x + 7$ | 6. $y = -\frac{2}{3}x + 4$
$y = \frac{1}{3}x - 2$ | 7. $y = 4.5 - x$
$y = -2x + 6$ | 8. $y = 4x$
$y = x + 1$ |

For each problem, define your variables, write a system of equations, and solve them by using the equal values method.

- Janelle has \$20 and is saving \$6 per week. April has \$150 and is spending \$4 per week. When will they both have the same amount of money?
- Sam and Hector are gaining weight for football season. Sam weighs 205 pounds and is gaining two pounds per week. Hector weighs 195 pounds but is gaining three pounds per week. In how many weeks will they both weigh the same amount?
- PhotosFast charges a fee of \$2.50 plus \$0.05 for each picture developed. PhotosQuick charges a fee of \$3.70 plus \$0.03 for each picture developed. For how many pictures will the total cost be the same at each shop?
- Playland Park charges \$7 admission plus 75¢ per ride. Funland Park charges \$12.50 admission plus 50¢ per ride. For what number of rides is the total cost the same at both parks?

Change one or both equations to y -form if necessary and solve by the substitution method.

- | | | | |
|----------------------------------|----------------------------------|----------------------------------|-------------------------------------|
| 13. $y = 2x - 3$
$x + y = 15$ | 14. $y = 3x + 11$
$x + y = 3$ | 15. $x + y = 5$
$2y - x = -2$ | 16. $x + 2y = 10$
$3x - 2y = -2$ |
| 17. $x + y = 3$
$2x - y = -9$ | 18. $y = 2x - 3$
$x - y = -4$ | 19. $x + 2y = 4$
$x + 2y = 6$ | 20. $3x = y - 2$
$6x + 4 = 2y$ |

Answers

- | | | | |
|-------------------|---------------------|-------------------------|---------------------------------|
| 1. (3, 5) | 2. (-3, -4) | 3. (3, 5) | 4. $(\frac{1}{2}, 2)$ |
| 5. (4.4, 9.2) | 6. (6, 0) | 7. (1.5, 3) | 8. $(\frac{1}{3}, \frac{4}{3})$ |
| 9. 13 weeks, \$98 | 10. 10 wks, 225 lbs | 11. 60 pictures, \$5.50 | 12. 22 rides, \$23.50 |
| 13. (6, 9) | 14. (-2, 5) | 15. (4, 1) | 16. (2, 4) |
| 17. (-2, 5) | 18. (7, 11) | 19. none | 20. infinite |

MULTIPLYING POLYNOMIALS

#12

We can use generic rectangles as area models to find the products of polynomials. A generic rectangle helps us organize the problem. It does not have to be drawn accurately or to scale. Also see the textbook, pages 192, 196-98, and 218.

Example 1

Multiply $(2x + 5)(x + 3)$

3		
+		
x		
	$2x$	$+ 5$

 \longrightarrow

3	$6x$	15
+		
x	$2x^2$	$5x$
	$2x$	$+ 5$

 $(2x + 5)(x + 3) = 2x^2 + 11x + 15$
area as a product area as a sum

Example 2

Multiply $(x + y)(x + 2)$

y		
+		
x		
	x	$+ 2$

 \longrightarrow

y	xy	$2y$
+		
x	x^2	$2x$
	x	$+ 2$

 $(x + y)(x + 2) = x^2 + xy + 2x + 2y$
area as a product area as a sum

Example 3

Multiply $(x + 9)(x^2 - 3x + 5)$

9			
+			
x			
	x^2	$- 3x$	$+ 5$

 \longrightarrow

9	$9x^2$	$-27x$	45
+			
x	x^3	$-3x^2$	$5x$
	x^2	$- 3x$	$+ 5$

$$\text{Therefore } (x + 9)(x^2 - 3x + 5) = x^3 + 9x^2 - 3x^2 - 27x + 5x + 45 = x^3 + 6x^2 - 22x + 45$$

Another approach to multiplying binomials is to use the mnemonic "F.O.I.L." F.O.I.L. is an acronym for First, Outside, Inside, Last in reference to the positions of the terms in the two binomials.

Example 4

Multiply $(3x - 2)(4x + 5)$ using the F.O.I.L. method.

F. multiply the FIRST terms of each binomial	$(3x)(4x) = 12x^2$
O. multiply the OUTSIDE terms	$(3x)(5) = 15x$
I. multiply the INSIDE terms	$(-2)(4x) = -8x$
L. multiply the LAST terms of each binomial	$(-2)(5) = -10$

Finally, we combine like terms: $12x^2 + 15x - 8x - 10 = 12x^2 + 7x - 10$.

Multiply, then simplify each expression.

- | | | |
|------------------------------|--------------------------|------------------------------|
| 1. $x(2x - 3)$ | 2. $y(3y - 4)$ | 3. $2y(y^2 + 3y - 2)$ |
| 4. $3x(2x^2 - x + 3)$ | 5. $(x + 2)(x + 7)$ | 6. $(y - 3)(y - 9)$ |
| 7. $(y - 2)(y + 7)$ | 8. $(x + 8)(x - 7)$ | 9. $(2x + 1)(3x - 5)$ |
| 10. $(3m - 2)(2m + 1)$ | 11. $(2m + 1)(2m - 1)$ | 12. $(3y - 4)(3y + 4)$ |
| 13. $(3x + 7)^2$ | 14. $(2x - 5)^2$ | 15. $(3x + 2)(x^2 - 5x + 2)$ |
| 16. $(y - 2)(3y^2 + 2y - 2)$ | 17. $3(x + 2)(2x - 1)$ | 18. $-2(x - 2)(3x + 1)$ |
| 19. $x(2x - 3)(x + 4)$ | 20. $2y(2y - 1)(3y + 2)$ | |

Answers

- | | | |
|----------------------------|-------------------------|-----------------------------|
| 1. $2x^2 - 3x$ | 2. $3y^2 - 4y$ | 3. $2y^3 + 6y^2 - 4y$ |
| 4. $6x^3 - 3x^2 + 9x$ | 5. $x^2 + 9x + 14$ | 6. $y^2 - 12y + 27$ |
| 7. $y^2 + 5y - 14$ | 8. $x^2 + x - 56$ | 9. $6x^2 - 7x - 5$ |
| 10. $6m^2 - m - 2$ | 11. $4m^2 - 1$ | 12. $9y^2 - 16$ |
| 13. $9x^2 + 42x + 49$ | 14. $4x^2 - 20x + 25$ | 15. $3x^3 - 13x^2 - 4x + 4$ |
| 16. $3y^3 - 4y^2 - 6y + 4$ | 17. $6x^2 + 9x - 6$ | 18. $-6x^2 + 10x + 4$ |
| 19. $2x^3 + 5x^2 - 12x$ | 20. $12y^3 + 2y^2 - 4y$ | |

WRITING AND GRAPHING LINEAR EQUATIONS ON A FLAT SURFACE #13

SLOPE is a number that indicates the steepness (or flatness) of a line, as well as its direction (up or down) left to right.

SLOPE is determined by the ratio: $\frac{\text{vertical change}}{\text{horizontal change}}$ between any two points on a line.

For lines that go **up** (from left to right), the sign of the slope is **positive**. For lines that go **down** (left to right), the sign of the slope is **negative**.

Any linear equation written as $y = mx + b$, where m and b are any real numbers, is said to be in **SLOPE-INTERCEPT FORM**. m is the **SLOPE** of the line. b is the **Y-INTERCEPT**, that is, the point $(0, b)$ where the line intersects (crosses) the y -axis.

If two lines have the same slope, then they are parallel. Likewise, **PARALLEL LINES** have the same slope.

Two lines are **PERPENDICULAR** if the slope of one line is the negative reciprocal of the slope of the other line, that is, m and $-\frac{1}{m}$. Note that $m \cdot \left(-\frac{1}{m}\right) = -1$.

Examples: 3 and $-\frac{1}{3}$, $-\frac{2}{3}$ and $\frac{3}{2}$, $\frac{5}{4}$ and $-\frac{4}{5}$

Two distinct lines that are not parallel intersect in a single point. See "Solving Linear Systems" to review how to find the point of intersection.

Also see the textbook, pages 205, 258, 291, 298, 301, 307-08, and 314.

Example 1

Write the slope of the line containing the points $(-1, 3)$ and $(4, 5)$.

First graph the two points and draw the line through them.

Look for and draw a slope triangle using the two given points.

Write the ratio $\frac{\text{vertical change in } y}{\text{horizontal change in } x}$ using the legs of the right triangle: $\frac{2}{5}$.

Assign a positive or negative value to the slope (this one is positive) depending on whether the line goes up (+) or down (-) from left to right.

If the points are inconvenient to graph, use a "Generic Slope Triangle", visualizing where the points lie with respect to each other.

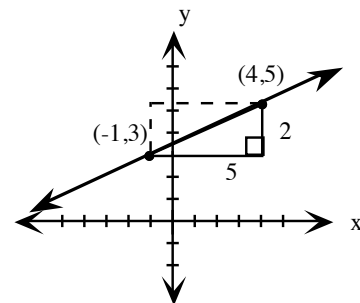

Example 2

Graph the linear equation $y = \frac{4}{7}x + 2$

Using $y = mx + b$, the slope in $y = \frac{4}{7}x + 2$ is $\frac{4}{7}$ and the y-intercept is the point $(0, 2)$. To graph, begin at the y-intercept $(0, 2)$. Remember that slope is $\frac{\text{vertical change}}{\text{horizontal change}}$ so go up 4 units (since 4 is positive) from $(0, 2)$ and then move right 7 units. This gives a second point on the graph. To create the graph, draw a straight line through the two points.

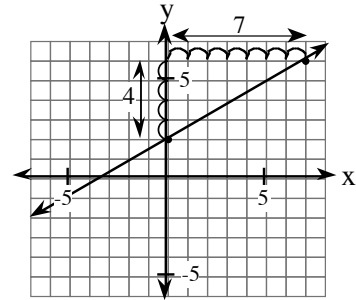

Example 3

A line has a slope of $\frac{3}{4}$ and passes through $(3, 2)$. What is the equation of the line?

Using $y = mx + b$, write $y = \frac{3}{4}x + b$. Since $(3, 2)$ represents a point (x, y) on the line,

substitute 3 for x and 2 for y , $2 = \frac{3}{4}(3) + b$, and solve for b .

$$2 = \frac{9}{4} + b \Rightarrow 2 - \frac{9}{4} = b \Rightarrow -\frac{1}{4} = b. \text{ The equation is } y = \frac{3}{4}x - \frac{1}{4}.$$

Example 4

Decide whether the two lines at right are parallel, perpendicular, or neither (i.e., intersecting).

$$5x - 4y = -6 \text{ and } -4x + 5y = 3.$$

First find the slope of each equation. Then compare the slopes.

$5x - 4y = -6$ $-4y = -5x - 6$ $y = \frac{-5x - 6}{-4}$ $y = \frac{5}{4}x + \frac{3}{2}$ <p>The slope of this line is $\frac{5}{4}$.</p>	$-4x + 5y = 3$ $5y = 4x + 3$ $y = \frac{4x + 3}{5}$ $y = \frac{4}{5}x + \frac{3}{5}$ <p>The slope of this line is $\frac{4}{5}$.</p>	<p>These two slopes are not equal, so they are not parallel. The product of the two slopes is 1, not -1, so they are not perpendicular. These two lines are neither parallel nor perpendicular, but do intersect.</p>
---	---	---

Example 5

Find two equations of the line through the given point, one parallel and one perpendicular to the given line: $y = -\frac{5}{2}x + 5$ and $(-4, 5)$.

<p>For the parallel line, use $y = mx + b$ with the same slope to write $y = -\frac{5}{2}x + b$.</p> <p>Substitute the point $(-4, 5)$ for x and y and solve for b.</p> $5 = -\frac{5}{2}(-4) + b \Rightarrow 5 = \frac{20}{2} + b \Rightarrow -5 = b$ <p>Therefore the parallel line through $(-4, 5)$ is $y = -\frac{5}{2}x - 5$.</p>	<p>For the perpendicular line, use $y = mx + b$ where m is the negative reciprocal of the slope of the original equation to write $y = \frac{2}{5}x + b$.</p> <p>Substitute the point $(-4, 5)$ and solve for b.</p> $5 = \frac{2}{5}(-4) + b \Rightarrow \frac{33}{5} = b$ <p>Therefore the perpendicular line through $(-4, 5)$ is $y = \frac{2}{5}x + \frac{33}{5}$.</p>
---	--

Write the slope of the line containing each pair of points.

- (3, 4) and (5, 7)
- (5, 2) and (9, 4)
- (1, -3) and (-4, 7)
- (-2, 1) and (2, -2)
- (-2, 3) and (4, 3)
- (8, 5) and (3, 5)

Use a Generic Slope Triangle to write the slope of the line containing each pair of points:

- (51, 40) and (33, 72)
- (20, 49) and (54, 90)
- (10, -13) and (-61, 20)

Identify the y-intercept in each equation.

- $y = \frac{1}{2}x - 2$
- $y = -\frac{3}{5}x - \frac{5}{3}$
- $3x + 2y = 12$
- $x - y = -13$
- $2x - 4y = 12$
- $4y - 2x = 12$

Write the equation of the line with:

- slope = $\frac{1}{2}$ and passing through (4, 3).
- slope = $\frac{2}{3}$ and passing through (-3, -2).
- slope = $-\frac{1}{3}$ and passing through (4, -1).
- slope = -4 and passing through (-3, 5).

Determine the slope of each line using the highlighted points.

20.

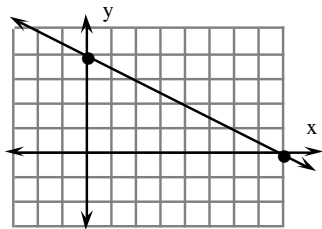

21.

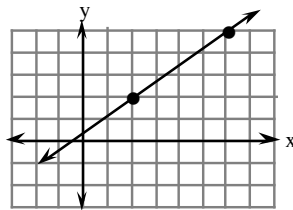

22.

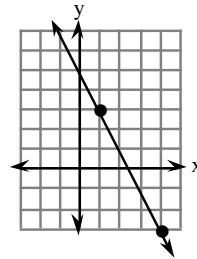

Using the slope and y-intercept, determine the equation of the line.

23.

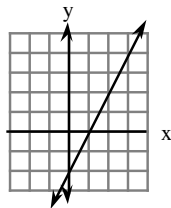

24.

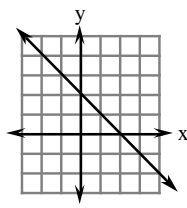

25.

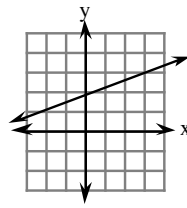

26.

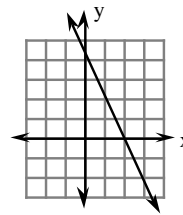

Graph the following linear equations on graph paper.

27. $y = \frac{1}{2}x + 3$

28. $y = -\frac{3}{5}x - 1$

29. $y = 4x$

30. $y = -6x + \frac{1}{2}$

31. $3x + 2y = 12$

State whether each pair of lines is parallel, perpendicular, or intersecting.

32. $y = 2x - 2$ and $y = 2x + 4$

33. $y = \frac{1}{2}x + 3$ and $y = -2x - 4$

34. $x - y = 2$ and $x + y = 3$

35. $y - x = -1$ and $y + x = 3$

36. $x + 3y = 6$ and $y = -\frac{1}{3}x - 3$

37. $3x + 2y = 6$ and $2x + 3y = 6$

38. $4x = 5y - 3$ and $4y = 5x + 3$

39. $3x - 4y = 12$ and $4y = 3x + 7$

Find an equation of the line through the given point and parallel to the given line.

40. $y = 2x - 2$ and $(-3, 5)$

41. $y = \frac{1}{2}x + 3$ and $(-4, 2)$

42. $x - y = 2$ and $(-2, 3)$

43. $y - x = -1$ and $(-2, 1)$

44. $x + 3y = 6$ and $(-1, 1)$

45. $3x + 2y = 6$ and $(2, -1)$

46. $4x = 5y - 3$ and $(1, -1)$

47. $3x - 4y = 12$ and $(4, -2)$

Find an equation of the line through the given point and perpendicular to the given line.

48. $y = 2x - 2$ and $(-3, 5)$

49. $y = \frac{1}{2}x + 3$ and $(-4, 2)$

50. $x - y = 2$ and $(-2, 3)$

51. $y - x = -1$ and $(-2, 1)$

52. $x + 3y = 6$ and $(-1, 1)$

53. $3x + 2y = 6$ and $(2, -1)$

54. $4x = 5y - 3$ and $(1, -1)$

55. $3x - 4y = 12$ and $(4, -2)$

Write an equation of the line parallel to each line below through the given point.

56.

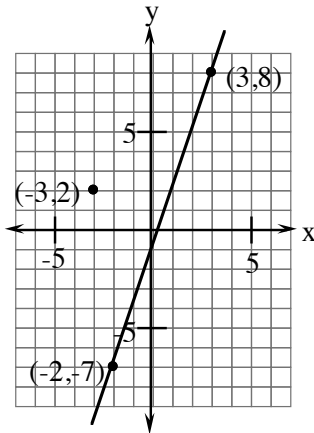

57.

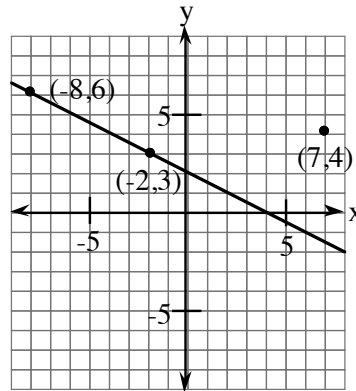

Answers

1. $\frac{3}{2}$
2. $\frac{1}{2}$
3. -2
4. $-\frac{3}{4}$
5. 0
6. 0
7. $-\frac{16}{9}$
8. $\frac{41}{34}$
9. $\frac{-33}{71}$
10. $(0, -2)$
11. $(0, -\frac{5}{3})$
12. $(0, 6)$
13. $(0, 13)$
14. $(0, -3)$
15. $(0, 3)$
16. $y = \frac{1}{2}x + 1$
17. $y = \frac{2}{3}x$
18. $y = -\frac{1}{3}x + \frac{1}{3}$
19. $y = -4x - 7$
20. $-\frac{1}{2}$
21. $\frac{3}{4}$
22. -2
23. $y = 2x - 2$
24. $y = -x + 2$
25. $y = \frac{1}{3}x + 2$
26. $y = -2x + 4$
27. line with slope $\frac{1}{2}$ and y-intercept $(0, 3)$
28. line with slope $-\frac{3}{5}$ and y-intercept $(0, -1)$
29. line with slope 4 and y-intercept $(0, 0)$
30. line with slope -6 and y-intercept $(0, \frac{1}{2})$
31. line with slope $-\frac{3}{2}$ and y-intercept $(0, 6)$
32. parallel
33. perpendicular
34. perpendicular
35. perpendicular
36. parallel
37. intersecting
38. intersecting
39. parallel
40. $y = 2x + 11$
41. $y = \frac{1}{2}x + 4$
42. $y = x + 5$
43. $y = x + 3$
44. $y = -\frac{1}{3}x + \frac{2}{3}$
45. $y = -\frac{3}{2}x + 2$
46. $y = \frac{4}{5}x - \frac{9}{5}$
47. $y = \frac{3}{4}x - 5$
48. $y = -\frac{1}{2}x + \frac{7}{2}$
49. $y = -2x - 6$
50. $y = -x + 1$
51. $y = -x - 1$
52. $y = 3x + 4$
53. $y = \frac{2}{3}x - \frac{7}{3}$
54. $y = -\frac{5}{4}x + \frac{1}{4}$
55. $y = -\frac{4}{3}x + \frac{10}{3}$
56. $y = 3x + 11$
57. $y = -\frac{1}{2}x + \frac{15}{2}$

USING ELIMINATION (ADDITION) TO FIND THE POINT OF INTERSECTION OF TWO LINES

#14

The **elimination** method can be used to solve a system of linear equations. By adding or subtracting the two linear equations in a way that eliminates one of the variables, a single variable equation is left. Also see the textbook, pages 250, 252, 254, and 264.

Example 1

$$\text{Solve: } \begin{cases} x + 2y = 16 \\ x + y = 2 \end{cases}$$

First decide whether to add or subtract the equations. Remember that the addition or subtraction should eliminate one variable. In the system above, the x in each equation is positive, so we need to subtract, that is, change all the signs of the terms in the second equation.

$$\begin{array}{r} x + 2y = 16 \\ -(x + y = 2) \Rightarrow -x - y = -2 \end{array} \Rightarrow \begin{array}{r} x + 2y = 16 \\ -x - y = -2 \end{array} \Rightarrow y = 14$$

Substitute the solution for y into either of the original equations to solve for the other variable, x .

$$x + 2(14) = 16 \Rightarrow x = -12$$

Check your solution $(-12, 14)$ in the second equation. You could also use the first equation to check your solution.

$$-12 + 14 = 2 \Rightarrow 2 = 2 \checkmark$$

Example 2

$$\text{Solve: } \begin{cases} 2x + 3y = 10 \\ 3x - 4y = -2 \end{cases}$$

Sometimes the equations need to be adjusted by multiplication before they can be added or subtracted to eliminate a variable. Multiply one or both equations to set them up for elimination.

Multiply the first equation by 3:

$$3(2x + 3y) = 10(3) \Rightarrow 6x + 9y = 30$$

Multiply the second equation by -2:

$$-2(3x - 4y) = -2 \cdot (-2) \Rightarrow -6x + 8y = 4$$

Decide whether to add or subtract the equations to eliminate one variable. Since the x -terms are additive opposites, add these equations.

$$\begin{array}{r} 6x + 9y = 30 \\ -6x + 8y = 4 \\ \hline 17y = 34 \end{array} \text{ so } y = 2.$$

Substitute the solution for y into either of the original equations to solve for the other variable.

$$2x + 3(2) = 10 \Rightarrow 2x = 4 \Rightarrow x = 2 \checkmark$$

Check the solution $(2, 2)$ in the second equation.

$$3(2) - 4(2) = -2 \Rightarrow 6 - 8 = -2 \Rightarrow -2 = -2$$

Solve each system of linear equations using the Elimination Method.

- | | | |
|--------------------------------------|--|---------------------------------------|
| 1. $x + y = -4$
$-x + 2y = 13$ | 2. $3x - y = 1$
$-2x + y = 2$ | 3. $2x + 5y = 1$
$2x - y = 19$ |
| 4. $x + 3y = 1$
$2x + 3y = -4$ | 5. $x - 5y = 1$
$x - 4y = 2$ | 6. $3x - 2y = -2$
$5x - 2y = 10$ |
| 7. $x + y = 10$
$15x + 28y = 176$ | 8. $x + 2y = 21$
$9x + 24y = 243$ | 9. $4x + 3y = 7$
$2x - 9y = 35$ |
| 10. $2x + 3y = 0$
$6x - 5y = -28$ | 11. $7x - 3y = 37$
$2x - y = 12$ | 12. $5x - 4y = 10$
$3x - 2y = 6$ |
| 13. $x - 7y = 4$
$3x + y = -10$ | 14. $y = -4x + 3$
$3x + 5y = -19$ | 15. $2x - 3y = 50$
$7x + 8y = -10$ |
| 16. $5x + 6y = 16$
$3x = 4y + 2$ | 17. $3x + 2y = 14$
$3y = -2x + 1$ | 18. $2x + 3y = 10$
$5x - 4y = 2$ |
| 19. $5x + 2y = 9$
$2x + 3y = -3$ | 20. $10x + 3y = 15$
$3x - 2y = -10$ | |

Answers

- | | | | |
|--------------|-------------|---------------|------------|
| 1. (-7, 3) | 2. (3, 8) | 3. (8, -3) | 4. (-5, 2) |
| 5. (6, 1) | 6. (6, 10) | 7. (8, 2) | 8. (3, 9) |
| 9. (4, -3) | 10. (-3, 2) | 11. (1, -10) | 12. (2, 0) |
| 13. (-3, -1) | 14. (2, -5) | 15. (10, -10) | 16. (2, 1) |
| 17. (8, -5) | 18. (2, 2) | 19. (3, -3) | 20. (0, 5) |

FACTORIZING POLYNOMIALS

#15

Often we want to un-multiply or **factor** a polynomial $P(x)$. This process involves finding a constant and/or another polynomial that evenly divides the given polynomial. In formal mathematical terms, this means $P(x) = q(x) \cdot r(x)$, where q and r are also polynomials. For elementary algebra there are three general types of factoring. Also see the textbook, pages 329, 331-32, 337-38, and 497.

- 1) **Common term** (finding the largest common factor):

$$6x + 18 = 6(x + 3) \text{ where } 6 \text{ is a common factor of both terms.}$$

$$2x^3 - 8x^2 - 10x = 2x(x^2 - 4x - 5) \text{ where } 2x \text{ is the common factor.}$$

$$2x^2(x - 1) + 7(x - 1) = (x - 1)(2x^2 + 7) \text{ where } x - 1 \text{ is the common factor.}$$

- 2) **Special products**

$$a^2 - b^2 = (a + b)(a - b) \quad x^2 - 25 = (x + 5)(x - 5)$$

$$9x^2 - 4y^2 = (3x + 2y)(3x - 2y)$$

$$x^2 + 2xy + y^2 = (x + y)^2 \quad x^2 + 8x + 16 = (x + 4)^2$$

$$x^2 - 2xy + y^2 = (x - y)^2 \quad x^2 - 8x + 16 = (x - 4)^2$$

- 3) Trinomials of the form $ax^2 + bx + c$

Recall that when using generic rectangles to multiply binomials, the product of the terms of the diagonals are equal.

For example in multiplying $(2x + 3)(x - 2)$

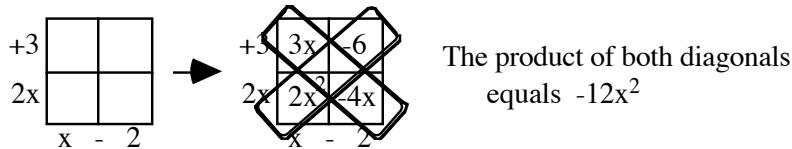

This fact and solving Diamond Problems will allow us to go backwards, that is, factor the trinomial.

Steps

- Place the x^2 and the constant terms in opposite corners of the rectangle. Determine the sum and product of the two remaining corners. The sum is the x -term of the expression and the product is equal to the product of the x^2 and constant terms.
- Place this sum and product into the Diamond Problem and solve.
- Place the solutions from the Diamond Problem into the generic rectangle and find the dimensions of the rectangle.
- Check the diagonals and write the dimensions as a product.

Example 1
 $2x^2 + 7x + 3$

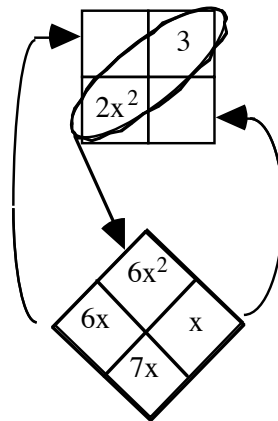

$$\begin{array}{r} 3 \\ + \\ x \end{array} \begin{array}{|c|c|} \hline 6x & 3 \\ \hline 2x^2 & x \\ \hline \end{array}$$

$$\begin{array}{c} 2x + 1 \\ (2x + 1)(x + 3) \end{array}$$

Example 2
 $5x^2 - 13x + 6$

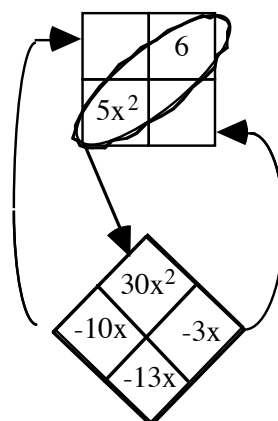

$$\begin{array}{r} -2 \\ + \\ x \end{array} \begin{array}{|c|c|} \hline -10x & 6 \\ \hline 5x^2 & -3x \\ \hline \end{array}$$

$$\begin{array}{c} 5x - 3 \\ (5x - 3)(x - 2) \end{array}$$

Polynomials with four or more terms are generally factored by grouping the terms and using one or more of the three procedures shown above. Note that polynomials are usually factored completely. In the second example in part (1) above, the trinomial also needs to be factored. Thus, the complete factorization of $2x^3 - 8x^2 - 10x = 2x(x^2 - 4x - 5) = 2x(x - 5)(x + 1)$.

Factor each polynomial completely.

- $x^2 - x - 42$
- $4x^2 - 18$
- $2x^2 + 9x + 9$
- $2x^2 + 3xy + y^2$
- $6x^2 - x - 15$
- $4x^2 - 25$
- $x^2 - 28x + 196$
- $7x^2 - 847$
- $x^2 + 18x + 81$
- $x^2 + 4x - 21$
- $3x^2 + 21x$
- $3x^2 - 20x - 32$
- $9x^2 - 16$
- $4x^2 + 20x + 25$
- $x^2 - 5x + 6$
- $5x^3 + 15x^2 - 20x$
- $4x^2 + 18$
- $x^2 - 12x + 36$
- $x^2 - 3x - 54$
- $6x^2 - 21$
- $2x^2 + 15x + 18$
- $16x^2 - 1$
- $x^2 - 14x + 49$
- $x^2 + 8x + 15$
- $3x^3 - 12x^2 - 45x$
- $3x^2 + 24$
- $x^2 + 16x + 64$

Factor completely.

28. $75x^3 - 27x$

31. $5y^2 - 125$

34. $3x^3 - 6x^2 - 45x$

37. $2x^2 + 5x - 7$

40. $4x^2 - 13x + 3$

43. $64x^2 + 16x + 1$

29. $3x^3 - 12x^2 - 36x$

32. $3x^2y^2 - xy^2 - 4y^2$

35. $3x^2 - 27$

38. $3x^2 - 13x + 4$

41. $4x^2 + 12x + 5$

44. $7x^2 - 33x - 10$

30. $4x^3 - 44x^2 + 112x$

33. $x^3 + 10x^2 - 24x$

36. $x^4 - 16$

39. $2x^2 + 9x + 10$

42. $6x^3 + 31x^2 + 5x$

45. $5x^2 + 12x - 9$

Answers

1. $(x + 6)(x - 7)$

4. $(2x + y)(x + y)$

7. $(x - 14)^2$

10. $(x + 7)(x - 3)$

13. $(3x - 4)(3x + 4)$

16. $5x(x + 4)(x - 1)$

19. $(x - 9)(x + 6)$

22. $(4x + 1)(4x - 1)$

25. $3x(x^2 - 4x - 15)$

28. $3x(5x - 3)(5x + 3)$

31. $5(y + 5)(y - 5)$

34. $3x(x - 5)(x + 3)$

37. $(2x + 7)(x - 1)$

40. $(4x - 1)(x - 3)$

43. $(8x + 1)^2$

2. $2(2x^2 - 9)$

5. $(2x + 3)(3x - 5)$

8. $7(x - 11)(x + 11)$

11. $3x(x + 7)$

14. $(2x + 5)^2$

17. $2(2x^2 + 9)$

20. $3(2x^2 - 7)$

23. $(x - 7)^2$

26. $3(x^2 + 8)$

29. $3x(x - 6)(x + 2)$

32. $y^2(3x - 4)(x + 1)$

35. $3(x - 3)(x + 3)$

38. $(3x - 1)(x - 4)$

41. $(2x + 5)(2x + 1)$

44. $(7x + 2)(x - 5)$

3. $(2x + 3)(x + 3)$

6. $(2x - 5)(2x + 5)$

9. $(x + 9)^2$

12. $(x - 8)(3x + 4)$

15. $(x - 3)(x - 2)$

18. $(x - 6)^2$

21. $(2x + 3)(x + 6)$

24. $(x + 3)(x + 5)$

27. $(x + 8)^2$

30. $4x(x - 7)(x - 4)$

33. $x(x + 12)(x - 2)$

36. $(x - 2)(x + 2)(x^2 + 4)$

39. $(x + 2)(2x + 5)$

42. $x(6x + 1)(x + 5)$

45. $(5x - 3)(x + 3)$

ZERO PRODUCT PROPERTY AND QUADRATICS

#16

If $a \cdot b = 0$, then either $a = 0$ or $b = 0$.

Note that this property states that at least one of the factors **MUST** be zero. It is also possible that all of the factors are zero. This simple statement gives us a powerful result which is most often used with equations involving the products of binomials. For example, solve $(x + 5)(x - 2) = 0$.

By the Zero Product Property, since $(x + 5)(x - 2) = 0$, either $x + 5 = 0$ or $x - 2 = 0$. Thus, $x = -5$ or $x = 2$.

The Zero Product Property can be used to find where a quadratic equation crosses the x-axis. These points are the x-intercepts. In the example above, they would be $(-5, 0)$ and $(2, 0)$. Also see the textbook, pages 346-49.

Here are two more examples. Solve each quadratic equation and check each solution.

Example 1

$$(x + 4)(x - 7) = 0$$

By the Zero Product Property,
either $x + 4 = 0$ or $x - 7 = 0$
Solving, $x = -4$ or $x = 7$.

Checking,

$$\begin{aligned}(-4 + 4)(-4 - 7) &= 0 \\ (0)(-11) &= 0 \checkmark \\ (7 + 4)(7 - 7) &= 0 \\ (11)(0) &= 0 \checkmark\end{aligned}$$

Example 2

$$x^2 + 3x - 10 = 0$$

First factor $x^2 + 3x - 10 = 0$
into $(x + 5)(x - 2) = 0$
then $x + 5 = 0$ or $x - 2 = 0$,
so $x = -5$ or $x = 2$

Checking,

$$\begin{aligned}(-5 + 5)(-5 - 2) &= 0 \\ (0)(-7) &= 0 \checkmark \\ (2 + 5)(2 - 2) &= 0 \\ (7)(0) &= 0 \checkmark\end{aligned}$$

Solve each of the following quadratic equations.

1. $(x + 7)(x + 1) = 0$

2. $(x + 2)(x + 3) = 0$

3. $x(x - 2) = 0$

4. $x(x - 7) = 0$

5. $(3x - 3)(4x + 2) = 0$

6. $(2x + 5)(4x - 3) = 0$

7. $x^2 + 4x + 3 = 0$

8. $x^2 + 6x + 5 = 0$

9. $x^2 - 6x + 8 = 0$

10. $x^2 - 8x + 15 = 0$

11. $x^2 + x = 6$

12. $x^2 - x = 6$

13. $x^2 - 10x = -16$

14. $x^2 - 11x = -28$

Without graphing, find where each parabola crosses the x-axis.

15. $y = x^2 - 2x - 3$

16. $y = x^2 + 2x - 8$

17. $y = x^2 - x - 30$

18. $y = x^2 + 4x - 5$

19. $x^2 + 4x = 5 + y$

20. $x^2 - 3x = 10 + y$

Answers

1. $x = -7$ and $x = -1$

2. $x = -2$ and $x = -3$

3. $x = 0$ and $x = 2$

4. $x = 0$ and $x = 7$

5. $x = 1$ and $x = -\frac{1}{2}$

6. $x = \frac{-5}{2}$ and $x = \frac{3}{4}$

7. $x = -1$ and $x = -3$

8. $x = -1$ and $x = -5$

9. $x = 4$ and $x = 2$

10. $x = 5$ and $x = 3$

11. $x = -3$ and $x = 2$

12. $x = 3$ and $x = -2$

13. $x = 2$ and $x = 8$

14. $x = 4$ and $x = 7$

15. $(-1, 0)$ and $(3, 0)$

16. $(-4, 0)$ and $(2, 0)$

17. $(6, 0)$ and $(-5, 0)$

18. $(-5, 0)$ and $(1, 0)$

19. $(1, 0)$ and $(-5, 0)$

20. $(5, 0)$ and $(-2, 0)$

THE QUADRATIC FORMULA

#17

You have used factoring and the Zero Product Property to solve quadratic equations. You can solve any quadratic equation by using the **quadratic formula**.

$$\text{If } ax^2 + bx + c = 0, \quad \text{then } x = \frac{-b \pm \sqrt{b^2 - 4ac}}{2a} .$$

For example, suppose $3x^2 + 7x - 6 = 0$. Here $a = 3$, $b = 7$, and $c = -6$.
Substituting these values into the formula results in:

$$x = \frac{-(7) \pm \sqrt{7^2 - 4(3)(-6)}}{2(3)} \Rightarrow x = \frac{-7 \pm \sqrt{121}}{6} \Rightarrow x = \frac{-7 \pm 11}{6}$$

Remember that non-negative numbers have both a positive and negative square root. The sign \pm represents this fact for the square root in the formula and allows us to write the equation once (representing two possible solutions) until later in the solution process.

Split the numerator into the two values: $x = \frac{-7 + 11}{6}$ or $x = \frac{-7 - 11}{6}$

Thus the solution for the quadratic equation is: $x = \frac{2}{3}$ or -3 .

Also see the textbook, pages 357-58.

Example 1

Solve: $x^2 + 7x + 5 = 0$

First make sure the equation is in standard form with zero on one side of the equation. This equation is already in standard form.

Second, list the numerical values of the coefficients a , b , and c . Since $ax^2 + bx + c = 0$, then $a = 1$, $b = 7$, and $c = 5$ for the equation $x^2 + 7x + 5 = 0$.

Write out the quadratic formula (see above). Substitute the numerical values of the coefficients a , b , and c in the quadratic

formula, $x = \frac{-7 \pm \sqrt{7^2 - 4(1)(5)}}{2(1)}$.

Simplify to get the exact solutions.

$$x = \frac{-7 \pm \sqrt{49 - 20}}{2} \Rightarrow x = \frac{-7 \pm \sqrt{29}}{2},$$

$$\text{so } x = \frac{-7 + \sqrt{29}}{2} \text{ or } \frac{-7 - \sqrt{29}}{2}$$

Use a calculator to get approximate solutions.

$$x \approx \frac{-7 + 5.39}{2} \approx \frac{-1.61}{2} \approx -0.81$$

$$x \approx \frac{-7 - 5.39}{2} \approx \frac{-12.39}{2} \approx -6.20$$

Example 2

Solve: $6x^2 + 1 = 8x$

First make sure the equation is in standard form with zero on one side of the equation.

$$\begin{array}{r} 6x^2 + 1 = 8x \\ -8x \quad -8x \\ \hline 6x^2 - 8x + 1 = 0 \end{array}$$

Second, list the numerical values of the coefficients a , b , and c : $a = 6$, $b = -8$, and $c = 1$ for this equation.

Write out the quadratic formula, then substitute the values in the formula.

$$x = \frac{-(-8) \pm \sqrt{(-8)^2 - 4(6)(1)}}{2(6)}$$

Simplify to get the exact solutions.

$$x = \frac{8 \pm \sqrt{64 - 24}}{12} \Rightarrow x = \frac{8 \pm \sqrt{40}}{12}$$

$$\text{so } x = \frac{8 + \sqrt{40}}{12} \text{ or } \frac{8 - \sqrt{40}}{12}$$

Use a calculator with the original answer to get approximate solutions.

$$x \approx \frac{8 + 6.32}{12} \approx \frac{14.32}{12} \approx 1.19$$

$$x \approx \frac{8 - 6.32}{12} \approx \frac{1.68}{12} \approx 0.14$$

Use the quadratic formula to solve the following equations.

1. $x^2 + 8x + 6 = 0$

2. $x^2 + 6x + 4 = 0$

3. $x^2 - 2x - 30 = 0$

4. $x^2 - 5x - 2 = 0$

5. $7 = 13x - x^2$

6. $15x - x^2 = 5$

7. $x^2 = -14x - 12$

8. $6x = x^2 + 3$

9. $3x^2 + 10x + 5 = 0$

10. $2x^2 + 8x + 5 = 0$

11. $5x^2 + 5x - 7 = 0$

12. $6x^2 - 2x - 3 = 0$

13. $2x^2 + 9x = -1$

14. $-6x + 6x^2 = 8$

15. $3x - 12 = -4x^2$

16. $10x^2 + 2x = 7$

17. $2x^2 - 11 = 0$

18. $3x^2 - 6 = 0$

19. $3x^2 + 0.75x - 1.5 = 0$

20. $0.1x^2 + 5x + 2.6 = 0$

Answers

1. $x \approx -0.84$ and -7.16

2. $x \approx -0.76$ and -5.24

3. $x \approx 6.57$ and -4.57

4. $x \approx 5.37$ and -0.37

5. $x \approx 12.44$ and 0.56

6. $x \approx 14.66$ and 0.34

7. $x \approx -0.92$ and -13.08

8. $x \approx 5.45$ and 0.55

9. $x \approx -0.61$ and -2.72

10. $x \approx -0.78$ and -3.22

11. $x \approx 0.78$ and -1.78

12. $x \approx 0.89$ and -0.56

13. $x \approx -0.11$ and -4.39

14. $x \approx 1.76$ and -0.76

15. $x \approx 1.40$ and -2.15

16. $x \approx 0.74$ and -0.94

17. $x \approx -2.35$ and 2.35

18. $x \approx -1.41$ and 1.41

19. $x \approx 0.59$ and -0.84

20. $x \approx -0.53$ and -49.47

SOLVING INEQUALITIES

#18

When an equation has a solution, depending on the type of equation, the solution can be represented as a point on a line or a point, line, or curve in the coordinate plane. Dividing points, lines, and curves are used to solve inequalities. Also see the textbook, pages 376-77, 386, 393, and 432.

If the inequality has one variable, the solution can be represented on a line. To solve any type of inequality, first solve it as you would if it were an equation. Use the solution(s) as dividing point(s) of the line. Then test a value from each region on the number line in the inequality. If the test value makes the inequality true, then that region is part of the solution. If it is false then the value and thus that region is not part of the solution. In addition, if the inequality is \geq or \leq then the dividing point is part of the solution and is indicated by a solid dot. If the inequality is $>$ or $<$, then the dividing point is not part of the solution and is indicated by an open dot.

Example 1

Solve $-2x - 3 \geq x + 6$

Solve the equation

$$\begin{aligned} -2x - 3 &= x + 6 \\ -2x &= x + 9 \\ -3x &= 9 \\ x &= -3 \end{aligned}$$

Draw a number line and put a solid dot at $x = -3$, which is the dividing point.

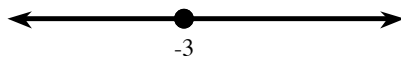

Test a value from each region. Here we test -4 and 0. Be sure to use the original inequality.

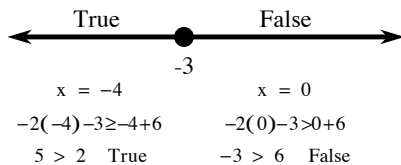

The region(s) that are true represent the solution. The solution is -3 and all numbers in the left region, written: $x \leq -3$.

Example 2

Solve $x^2 - 2x + 2 < 5$

Solve the equation

$$\begin{aligned} x^2 - 2x + 2 &= 5 \\ x^2 - 2x - 3 &= 0 \\ (x - 3)(x + 1) &= 0 \\ x = 3 \text{ or } x = -1 \end{aligned}$$

Draw a number line and put open dots at $x = 3$ and $x = -1$, the dividing points.

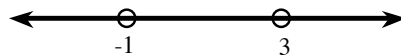

Test a value from each region in the original inequality. Here we test -3, 0, and 4.

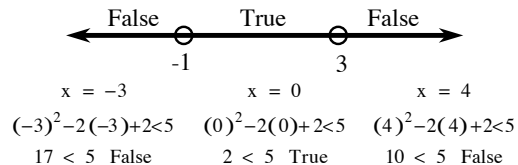

The region(s) that are true represent the solution. The solution is the set of all numbers greater than -1 but less than 3 , written: $-1 < x < 3$.

If the inequality has two variables, then the solution is represented by a graph in the xy -coordinate plane. The graph of the inequality written as an equation (a line or curve) divides the coordinate plane into regions which are tested in the same manner described above using an ordered pair for a point on a side of the dividing line or curve. If the inequality is $>$ or $<$, then the boundary line or curve is dashed. If the inequality is \geq or \leq , then the boundary line or curve is solid.

Example 3

Shade the solution to this system of inequalities $\begin{cases} y \leq \frac{2}{5}x \\ y > 5 - x \end{cases}$

Graph each equation. For $y = \frac{2}{5}x$ the slope of the solid line is $\frac{2}{5}$ and y -intercept is 0. For $y = 5 - x$ the slope of the dashed line is -1 and the y -intercept is 5.

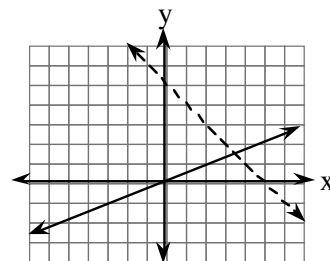

Test a point from each region in both of the original inequalities.

(0, 2)	(2, 0)	(4, 5)	(5, 1)
False in both	True in first, False in second	False in first, True in second	True in both

The region that makes both statements (inequalities) true is the solution.

The solution is the region below the solid line $y = \frac{2}{5}x$ and above the dashed line $y = 5 - x$ as shown at right.

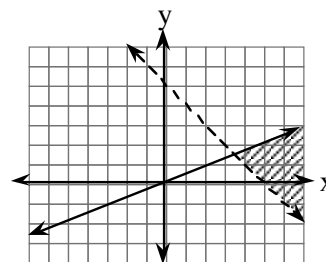

Solve and graph each inequality.

1. $x + 12 \geq 2x - 5$
2. $-16 + 4x > 10 - x$
3. $7x - 2x - x \geq 24 + 3x$
4. $3(x - 4) - 9x \geq 2x - 4$
5. $|x - 1| < 5$
6. $|x + 10| > 5$
7. $|12x| \geq 24$
8. $\left|\frac{x}{3}\right| < 8$
9. $x^2 + 3x - 10 \leq 0$
10. $x^2 - 7x + 6 > 0$
11. $x^2 + 2x - 8 \leq 7$
12. $x^2 - 5x - 16 > -2$
13. $y < 2x + 1$
14. $y \leq -\frac{2}{3}x + 3$
15. $y \geq \frac{1}{4}x - 2$
16. $2x - 3y \leq 5$
17. $y \geq -2$
18. $-3x - 4y > 4$
19. $y \leq \frac{1}{2}x + 2$ and $y > -\frac{2}{3}x - 1$.
20. $y \leq -\frac{3}{5}x + 4$ and $y \leq \frac{1}{3}x + 3$
21. $y < 3$ and $y \leq -\frac{1}{2}x + 2$
22. $x \leq 3$ and $y < \frac{3}{4}x - 4$
23. $y \leq x^2 + 4x + 3$
24. $y > x^2 - x - 2$

Answers

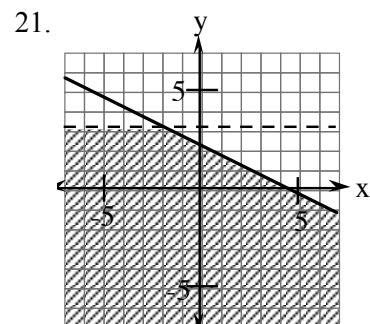
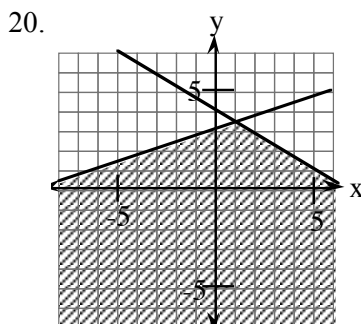
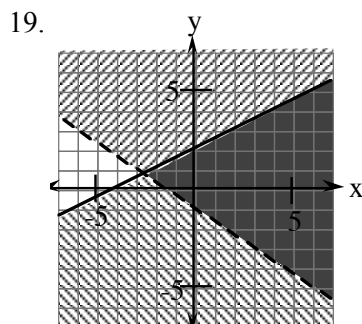
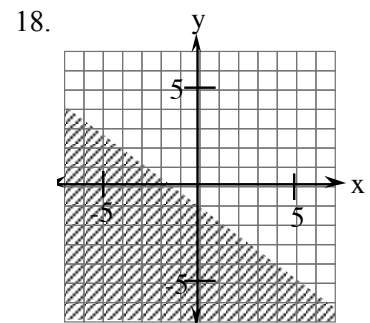
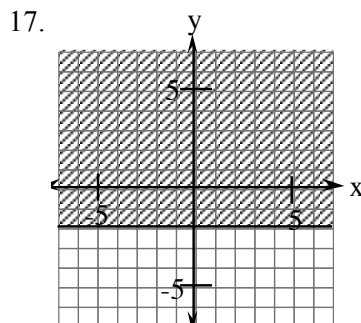
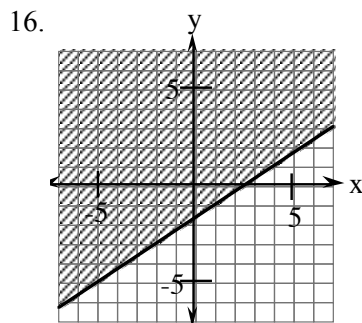
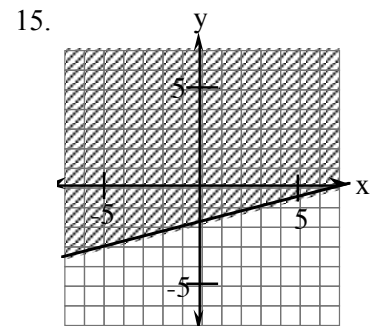
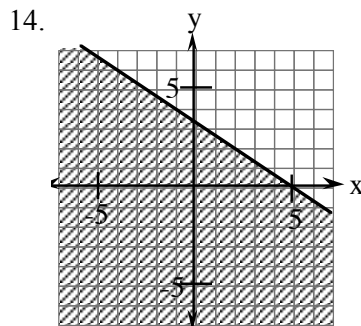
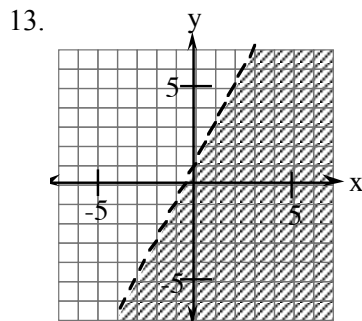
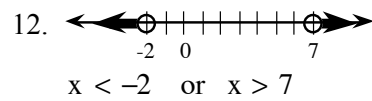
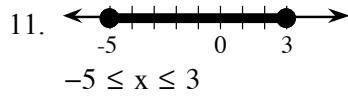
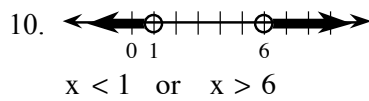
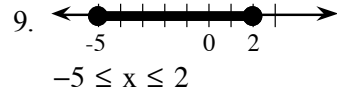
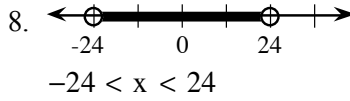
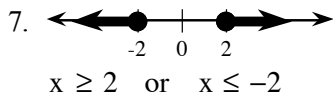
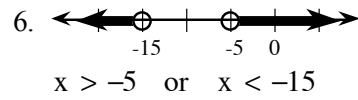
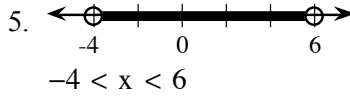
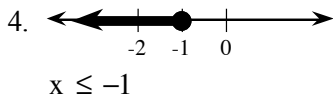
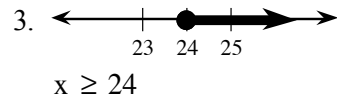
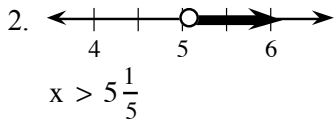
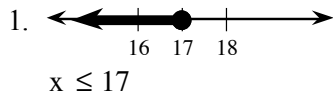

22.

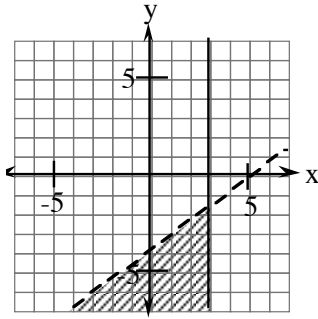

23.

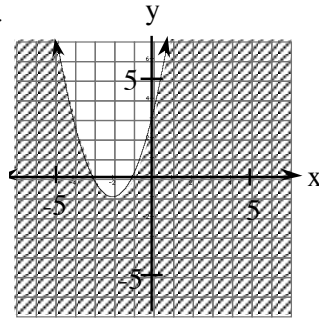

24.

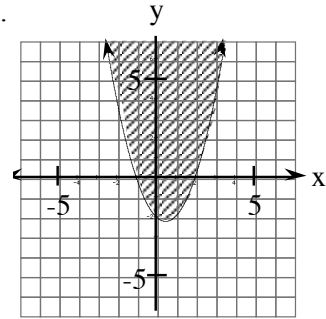

ABSOLUTE VALUE EQUATIONS

#19

Absolute value means the distance from a reference point. In the simplest case, the absolute value of a number is its distance from zero on the number line. Since absolute value is a distance, the result of finding an absolute value is zero or a positive number. All distances are positive. Also see the textbook, pages 430 and 432.

Example 1

$$\text{Solve } |2x + 3| = 7.$$

Because the result of $(2x + 3)$ can be 7 or -7, we can write and solve two different equations. (Remember that the absolute value of 7 and -7 will be 7.)

$$2x + 3 = 7 \text{ or } 2x + 3 = -7$$

$$2x = 4 \text{ or } 2x = -10$$

$$x = 2 \text{ or } x = -5$$

Example 2

$$\text{Solve } 2|2x + 13| = 10.$$

First the equation must have the absolute value isolated on one side of the equation.

$$2|2x + 13| = 10 \Rightarrow |2x + 13| = 5$$

Because the result of $2x + 13$ can be 5 or -5, we can write and solve two different equations.

$$2x + 13 = 5 \text{ or } 2x + 13 = -5$$

$$2x = -8 \text{ or } 2x = -18$$

$$x = -4 \text{ or } x = -9$$

Note that while some x-values of the solution are negative, the goal is to find values that make the original absolute value statement true. For $x = -5$ in example 1, $|2(-5) + 3| = 7 \Rightarrow |-10 + 3| = 7 \Rightarrow |-7| = 7$, which is true. Verify that the two negative values of x in example 2 make the original absolute value equation true.

Solve for x .

- | | | |
|---------------------------|-----------------------------------|-------------------------|
| 1. $ x + 2 = 4$ | 2. $ 3x = 27$ | 3. $ x - 5 = 2$ |
| 4. $ x - 8 = 2$ | 5. $\left \frac{x}{5}\right = 2$ | 6. $ -3x = 4$ |
| 7. $ 3x + 4 = 10$ | 8. $ 12x - 6 = 6$ | 9. $ x + 3 = 20$ |
| 10. $ x - 8 = -2$ | 11. $2 x - 5 = 3$ | 12. $4 x - 5 = 7$ |
| 13. $ x + 2 - 3 = 7$ | 14. $ x + 5 + 4 = 12$ | 15. $ 2x - 3 + 2 = 11$ |
| 16. $-3 x + 5 = -4$ | 17. $-3 x + 6 + 12 = 0$ | 18. $15 - x + 1 = 3$ |
| 19. $14 + 2 3x + 5 = 26$ | 20. $4 x - 10 - 23 = 37$ | |

Answers

- | | | | |
|-------------------|------------------------------------|--------------------------------------|------------------|
| 1. $x = 2, -6$ | 2. $x = 9, -9$ | 3. $x = 7, 3$ | 4. $x = 10, 6$ |
| 5. $x = 10, -10$ | 6. $x = -\frac{4}{3}, \frac{4}{3}$ | 7. $x = 2, -\frac{14}{3}$ | 8. $x = 1, 0$ |
| 9. $x = 17, -17$ | 10. $x = 6, -6$ | 11. $x = 4, -4$ | 12. $x = 3, -3$ |
| 13. $x = 8, -12$ | 14. $x = 3, -13$ | 15. $x = 6, -3$ | 16. $x = 3, -3$ |
| 17. $x = -2, -10$ | 18. $x = 11, -13$ | 19. $x = \frac{1}{3}, -\frac{11}{3}$ | 20. $x = 25, -5$ |

ABSOLUTE VALUE INEQUALITIES

20

To solve absolute value inequalities, rewrite the inequality without absolute value according to the two patterns below and solve in the usual ways.

1) $|x| \leq a$ is equivalent to $-a \leq x \leq a$

(all values of x that have a distance from 0 of less than or equal to “ a ”).

2) $|x| \geq a$ is equivalent to $x \geq a$ or $x \leq -a$

(all values of x that have a distance from 0 of greater than or equal to “ a ”).

For more complicated inequalities, follow the same patterns and simplify. Less than ($<$) and greater than ($>$) is solved in the same way as patterns one and two above using the appropriate sign. Also see the textbook, page 432.

Example 1

Solve: $|x| \leq 4$

Using pattern 1: $-4 \leq x \leq 4$

(all numbers between -4 and 4, inclusive).

Example 2

Solve: $|2y| > 4$

Using pattern 2: $2y > 4$ or $2y < -4$.

Simplify: $y > 2$ or $y < -2$

(all numbers above 2 or below -2)

Example 3

Solve: $|2y + 1| < 5$

Using pattern 1: $-5 < 2y + 1 < 5$

Simplify: $-6 < 2y < 4$

$-3 < y < 2$

(all numbers between -3 and 2)

Example 4

Solve: $|3x - 2| + 1 > 7$

Simplify: $|3x - 2| > 6$

Using pattern 2: $3x - 2 > 6$ or $3x - 2 < -6$

Simplify: $3x > 8$ or $3x < -4$

$x > \frac{8}{3}$ or $x < -\frac{4}{3}$

(all numbers above $\frac{8}{3}$ or below $-\frac{4}{3}$)

Solve each absolute value inequality.

1. $|x| \leq 3$

2. $|y| > 4$

3. $|2x| < 8$

4. $|3y| \geq 9$

5. $|x-1| < 7$

6. $|2y+1| \geq 11$

7. $|3m-1| \leq 5$

8. $|3m| + 7 < 10$

9. $|1+2y| > 10$

10. $\left| \frac{x}{2} - 3 \right| \leq 12$

11. $2|x| + 3 \leq 10$

12. $8|2x+1| - 1 < 63$

Answers

1. $-3 \leq x \leq 3$

2. $y > 4$ or $y < -4$

3. $-4 < x < 4$

4. $y > 3$ or $y < -3$

5. $-6 < x < 8$

6. $y \geq 5$ or $y \leq -6$

7. $-\frac{4}{3} \leq m \leq 2$

8. $-1 < m < 1$

9. $y > \frac{9}{2}$ or $y < -\frac{11}{2}$

10. $-18 \leq x \leq 30$

11. $-\frac{7}{2} \leq x \leq \frac{7}{2}$

12. $-\frac{9}{2} < x < \frac{7}{2}$

SIMPLIFYING RATIONAL EXPRESSIONS

#21

Rational expressions are fractions that have algebraic expressions in their numerators and/or denominators. To simplify rational expressions find **factors** in the numerator and denominator that are the same and then write them as fractions equal to 1. For example,

$$\frac{6}{6} = 1 \quad \frac{x^2}{x^2} = 1 \quad \frac{(x+2)}{(x+2)} = 1 \quad \frac{(3x-2)}{(3x-2)} = 1$$

Notice that the last two examples involved binomial sums and differences. **Only** when sums or differences are **exactly** the same does the fraction equal 1. Rational expressions such as the examples below **cannot** be simplified:

$$\frac{(6+5)}{6} \quad \frac{x^3+y}{x^3} \quad \frac{x}{x+2} \quad \frac{3x-2}{2}$$

Most problems that involve rational expressions will require that you **factor** the numerator and denominator. For example:

$$\frac{12}{54} = \frac{2 \cdot 2 \cdot 3}{2 \cdot 3 \cdot 3 \cdot 3} = \frac{2}{9} \quad \text{Notice that } \frac{2}{2} \text{ and } \frac{3}{3} \text{ each equal 1.}$$

$$\frac{6x^3y^2}{15x^2y^4} = \frac{2 \cdot 3 \cdot x^2 \cdot x \cdot y^2}{5 \cdot 3 \cdot x^2 \cdot y^2 \cdot y^2} = \frac{2x}{5y^2} \quad \text{Notice that } \frac{3}{3}, \frac{x^2}{x^2}, \text{ and } \frac{y^2}{y^2} = 1.$$

$$\frac{x^2 - x - 6}{x^2 - 5x + 6} = \frac{(x+2)(x-3)}{(x-2)(x-3)} = \frac{x+2}{x-2} \quad \text{where } \frac{x-3}{x-3} = 1.$$

All three examples demonstrate that **all parts** of the numerator and denominator--whether constants, monomials, binomials, or factorable trinomials--must be written as products **before** you can look for factors that equal 1.

One special situation is shown in the following examples:

$$\frac{-2}{2} = -1 \quad \frac{-x}{x} = -1 \quad \frac{-x-2}{x+2} = \frac{-(x+2)}{x+2} = -1 \quad \frac{5-x}{x-5} = \frac{-(x-5)}{x-5} = -1$$

Note that in all cases we assume the denominator does not equal zero.

Also see the textbook, pages 410 and 413.

Example 1

Simplify: $\frac{(a^3b^{-2})^2}{a^4}$

Rewrite the numerator and denominator without negative exponents and parentheses.

$$\frac{(a^3b^{-2})^2}{a^4} \Rightarrow \frac{a^6b^{-4}}{a^4} \Rightarrow \frac{a^6}{a^4b^4}$$

Then look for the same pairs of factors that equal one (1) when divided. Writing out all of the factors can be helpful.

$$\frac{a \cdot a \cdot a \cdot a \cdot a \cdot a}{a \cdot a \cdot a \cdot a \cdot b \cdot b \cdot b \cdot b} = 1 \cdot 1 \cdot 1 \cdot 1 \cdot \frac{a \cdot a}{b \cdot b \cdot b \cdot b}$$

Write the simplified expression with exponents.

$$\frac{(a^3b^{-2})^2}{a^4} = \frac{a^2}{b^4}, b \neq 0. \text{ Note that } \frac{a}{a} = 1.$$

Example 2

Simplify: $\frac{2x^2-13x-7}{x^2-4x-21}$

To simplify some rational expressions, the numerator and/or denominator may need to be factored before you may simplify the expression.

$$\frac{2x^2-13x-7}{x^2-4x-21} \Rightarrow \frac{(2x+1)(x-7)}{(x-7)(x+3)}$$

Then look for the same pairs of factors that equal one (1) when divided.

$$\frac{(2x+1)(x-7)}{(x+3)(x-7)} \Rightarrow \frac{2x+1}{x+3} \cdot 1 \Rightarrow \frac{2x+1}{x+3} \text{ for } x \neq -3 \text{ or } 7.$$

$$\text{Note that } \frac{(x-7)}{(x-7)} = 1.$$

Simplify the following expressions. Assume that the denominator is not equal to zero.

- | | | | |
|-----------------------------------|--|--------------------------------------|--|
| 1. | 2. $\frac{10a^6b^8}{40a^2b^2}$ | 3. $\frac{(x^5y^3)^3}{x^{12}y}$ | 4. $\frac{(a^5)^2}{a^{13}b^6}$ |
| 5. $\frac{(5x^3)^2y^3}{10xy^9}$ | 6. $\frac{3(a^3)^5b}{(3a^4)^3b^{10}}$ | 7. $\frac{4ab^{-5}}{a^8b}$ | 8. $\frac{2x^{-3}y^8}{4x^{-2}}$ |
| 9. $\frac{(x^8y^{-3})^{-2}}{x^2}$ | 10. $\frac{2x^3y^{-1}}{6(4x)^{-2}y^7}$ | 11. $\frac{(2x-1)(x+3)}{(x-5)(x+3)}$ | 12. $\frac{(5x-1)(x+2)}{(x+7)(5x-1)}$ |
| 13. $\frac{3x+1}{3x^2+10x+3}$ | 14. $\frac{x^2-x-20}{x-5}$ | 15. $\frac{3x-6}{x^2+4x-12}$ | 16. $\frac{2x^2-x-3}{10x-15}$ |
| 17. $\frac{3x^2+x-10}{x^2+6x+8}$ | 18. $\frac{x^2-64}{x^2+16x+64}$ | 19. $\frac{4x^2-x}{4x^3+11x^2-3x}$ | 20. $\frac{2x^3+2x^2-12x}{8x^2-8x-16}$ |

Answers

- | | | |
|--|--|---|
| 1. $4y$ | 2. $\frac{a^4b^6}{4}$ | 3. $\frac{x^{15}y^9}{x^{12}y} = x^3y^8$ |
| 4. $\frac{a^{10}}{a^{13}b^6} = \frac{1}{a^3b^6}$ | 5. $\frac{25x^6y^3}{10xy^9} = \frac{5x^5}{2y^6}$ | 6. $\frac{3a^{15}b}{27a^{12}b^{10}} = \frac{a^3}{9b^9}$ |
| 7. $\frac{4a}{a^8b^6} = \frac{4}{a^7b^6}$ | 8. $\frac{2x^2y^8}{4x^3} = \frac{y^8}{2x}$ | 9. $\frac{x^{-16}y^6}{x^2} = \frac{y^6}{x^{18}}$ |
| 10. $\frac{32x^5}{6y^8} = \frac{16x^5}{3y^8}$ | 11. $\frac{2x-1}{x-5}$ | 12. $\frac{x+2}{x+7}$ |
| 13. $\frac{3x+1}{(x+3)(3x+1)} = \frac{1}{x+3}$ | 14. $\frac{(x-5)(x+4)}{x-5} = x+4$ | 15. $\frac{3(x-2)}{(x-2)(x+6)} = \frac{3}{x+6}$ |
| 16. $\frac{(2x-3)(x+1)}{5(2x-3)} = \frac{x+1}{5}$ | 17. $\frac{(3x-5)(x+2)}{(x+4)(x+2)} = \frac{3x-5}{x+4}$ | 18. $\frac{(x+8)(x-8)}{(x+8)(x+8)} = \frac{x-8}{x+8}$ |
| 19. $\frac{x(4x-1)}{x(4x-1)(x+3)} = \frac{1}{x+3}$ | 20. $\frac{2x(x+3)(x-2)}{8(x-2)(x+1)} = \frac{x(x+3)}{4(x+1)} = \frac{x^2+3x}{4x+4}$ | |

MULTIPLICATION AND DIVISION OF RATIONAL EXPRESSIONS #22

To multiply or divide rational expressions, follow the same procedures used with numerical fractions. However, it is often necessary to factor the polynomials in order to simplify the rational expression. Also see the textbook, pages 412-13.

Example 1

Multiply $\frac{x^2 + 6x}{(x+6)^2} \cdot \frac{x^2 + 7x + 6}{x^2 - 1}$ and simplify the result.

After factoring, the expression becomes:

$$\frac{x(x+6)}{(x+6)(x+6)} \cdot \frac{(x+6)(x+1)}{(x+1)(x-1)}$$

After multiplying, reorder the factors:

$$\frac{(x+6)}{(x+6)} \cdot \frac{(x+6)}{(x+6)} \cdot \frac{x}{(x-1)} \cdot \frac{(x+1)}{(x+1)}$$

Since $\frac{(x+6)}{(x+6)} = 1$ and $\frac{(x+1)}{(x+1)} = 1$, simplify:

$$1 \cdot 1 \cdot \frac{x}{x-1} \cdot 1 \Rightarrow \frac{x}{x-1}$$

Note: $x \neq -6, -1, \text{ or } 1$.

Example 2

Divide $\frac{x^2 - 4x - 5}{x^2 - 4x + 4} \div \frac{x^2 - 2x - 15}{x^2 + 4x - 12}$ and simplify the result.

First, change to a multiplication expression by inverting (flipping) the second fraction:

$$\frac{x^2 - 4x - 5}{x^2 - 4x + 4} \cdot \frac{x^2 + 4x - 12}{x^2 - 2x - 15}$$

After factoring, the expression is:

$$\frac{(x-5)(x+1)}{(x-2)(x-2)} \cdot \frac{(x+6)(x-2)}{(x-5)(x+3)}$$

Reorder the factors (if you need to):

$$\frac{(x-5)}{(x-5)} \cdot \frac{(x-2)}{(x-2)} \cdot \frac{(x+1)}{(x-2)} \cdot \frac{(x+6)}{(x+3)}$$

Since $\frac{(x-5)}{(x-5)} = 1$ and $\frac{(x-2)}{(x-2)} = 1$, simplify:

$$\frac{(x+1)(x+6)}{(x-2)(x+3)}$$

Thus, $\frac{x^2 - 4x - 5}{x^2 - 4x + 4} \div \frac{x^2 - 2x - 15}{x^2 + 4x - 12} = \frac{(x+1)(x+6)}{(x-2)(x+3)}$ or $\frac{x^2 + 7x + 6}{x^2 + x - 6}$. Note: $x \neq -3, 2, \text{ or } 5$.

Multiply or divide each expression below and simplify the result. Assume the denominator is not equal to zero.

1. $\frac{3x+6}{5x} \cdot \frac{x+4}{x^2+2x}$
2. $\frac{8a}{a^2-16} \cdot \frac{a+4}{4}$
3. $\frac{x^2-1}{3} \cdot \frac{2}{x^2-x}$
4. $\frac{x^2-x-12}{x^2} \cdot \frac{x}{x-4}$
5. $\frac{x^2-16}{(x-4)^2} \cdot \frac{x^2-3x-18}{x^2-2x-24}$
6. $\frac{x^2+6x+8}{x^2-4x+3} \cdot \frac{x^2-5x+4}{5x+10}$
7. $\frac{x^2-x-6}{x^2-x-20} \cdot \frac{x^2+6x+8}{x^2-x-6}$
8. $\frac{x^2-x-30}{x^2+13x+40} \cdot \frac{x^2+11x+24}{x^2-9x+18}$
9. $\frac{3x+12}{x^2} \div \frac{x+4}{x}$
10. $\frac{2a+6}{a^3} \div \frac{a+3}{a}$
11. $\frac{15-5x}{x^2-x-6} \div \frac{5x}{x^2+6x+8}$
12. $\frac{17x+119}{x^2+5x-14} \div \frac{9x-1}{x^2-3x+2}$
13. $\frac{x^2+8x}{9x} \div \frac{x^2-64}{3x^2}$
14. $\frac{x^2-1}{x^2-6x-7} \div \frac{x^3+x^2-2x}{x-7}$
15. $\frac{2x^2-5x-3}{3x^2-10x+3} \div \frac{4x^2+4x+1}{9x^2-1}$
16. $\frac{x^2+3x-10}{x^2+3x} \div \frac{x^2-4x+4}{4x+12}$
17. $\frac{x^2-x-6}{x^2+3x-10} \cdot \frac{x^2+2x-15}{x^2-6x+9} \cdot \frac{x^2+4x-21}{x^2+9x+14}$
18. $\frac{3x^2+21x}{x^2-49} \cdot \frac{x^2-x}{6x^3-9x^2} \cdot \frac{4x^2-9}{3x-3}$
19. $\frac{4x^3+7x^2-2x}{2x^2-162} \div \frac{4x^2+15x-4}{12x-60} \cdot \frac{x^2+9x}{x^2-3x-10}$
20. $\frac{10x^2-11x+3}{x^2-6x-40} \cdot \frac{x^2+11x+28}{2x^2-x} \div \frac{x+7}{2x^2-20x}$

Answers

1. $\frac{3(x+4)}{5x^2} = \frac{3x+12}{5x^2}$
2. $\frac{2a}{a-4}$
3. $\frac{2(x+1)}{3x} = \frac{2x+2}{3x}$
4. $\frac{x+3}{x}$
5. $\frac{(x+3)}{(x-4)}$
6. $\frac{(x+4)(x-4)}{5(x-3)} = \frac{x^2-16}{5x-15}$
7. $\frac{(x+2)}{(x-5)}$
8. $\frac{(x+3)}{(x-3)}$
9. $\frac{3}{x}$
10. $\frac{2}{a^2}$
11. $\frac{-(x+4)}{x} = \frac{-x-4}{x}$
12. $\frac{17(x-1)}{9x-1} = \frac{17x-17}{9x-1}$
13. $\frac{x^2}{3(x-8)} = \frac{x^2}{3x-24}$
14. $\frac{1}{x(x+2)}$
15. $\frac{(3x+1)}{(2x+1)}$
16. $\frac{4(x+5)}{x(x-2)} = \frac{4x+20}{x^2-2x}$
17. $\frac{(x-3)}{(x-2)}$
18. $\frac{2x+3}{3(x-7)} = \frac{2x+3}{3x-21}$
19. $\frac{6x^2}{(x-9)(x+4)} = \frac{6x^2}{x^2-5x-36}$
20. $\frac{2(5x-3)}{1} = 10x-6$

SOLVING EQUATIONS CONTAINING ALGEBRAIC FRACTIONS #23

Fractions that appear in algebraic equations can usually be eliminated in one step by multiplying each term on both sides of the equation by the common denominator for all of the fractions. If you cannot determine the common denominator, use the product of all the denominators. Multiply, simplify each term as usual, then solve the remaining equation. In this course we call this method for eliminating fractions in equations "fraction busting." Also see the textbook, pages 418-19.

Example 1

$$\text{Solve for } x: \frac{x}{9} + \frac{2x}{5} = 3$$

$$45\left(\frac{x}{9} + \frac{2x}{5}\right) = 45(3)$$

$$45\left(\frac{x}{9}\right) + 45\left(\frac{2x}{5}\right) = 135$$

$$5x + 18x = 135$$

$$23x = 135$$

$$x = \frac{135}{23}$$

Example 2

$$\text{Solve for } x: \frac{5}{2x} + \frac{1}{6} = 8$$

$$6x\left(\frac{5}{2x} + \frac{1}{6}\right) = 6x(8)$$

$$6x\left(\frac{5}{2x}\right) + 6x\left(\frac{1}{6}\right) = 48x$$

$$15 + x = 48x$$

$$15 = 47x$$

$$x = \frac{15}{47}$$

Solve the following equations using the fraction busters method.

$$1. \frac{x}{6} + \frac{2x}{3} = 5$$

$$2. \frac{x}{3} + \frac{x}{2} = 1$$

$$3. \frac{16}{x} + \frac{16}{40} = 1$$

$$4. \frac{5}{x} + \frac{5}{3x} = 1$$

$$5. \frac{x}{2} - \frac{x}{5} = 9$$

$$6. \frac{x}{3} - \frac{x}{5} = \frac{2}{3}$$

$$7. \frac{x}{2} - 4 = \frac{x}{3}$$

$$8. \frac{x}{8} = \frac{x}{12} + \frac{1}{3}$$

$$9. 5 - \frac{7x}{6} = \frac{3}{2}$$

$$10. \frac{2x}{3} - x = 4$$

$$11. \frac{x}{8} = \frac{x}{5} - \frac{1}{3}$$

$$12. \frac{2x}{3} - \frac{3x}{5} = 2$$

$$13. \frac{4}{x} + \frac{2}{x} = 1$$

$$14. \frac{3}{x} + 2 = 4$$

$$15. \frac{5}{x} + 6 = \frac{17}{x}$$

$$16. \frac{2}{x} - \frac{4}{3x} = \frac{2}{9}$$

$$17. \frac{x+2}{3} + \frac{x-1}{6} = 5$$

$$18. \frac{x}{4} + \frac{x+5}{3} = 4$$

$$19. \frac{x-1}{2x} + \frac{x+3}{4x} = \frac{5}{8}$$

$$20. \frac{2-x}{x} - \frac{x+3}{3x} = \frac{-1}{3}$$

Answers

$$1. x = 6$$

$$2. x = \frac{6}{5}$$

$$3. x = 26\frac{2}{3}$$

$$4. x = 6\frac{2}{3}$$

$$5. x = 30$$

$$6. x = 5$$

$$7. x = 24$$

$$8. x = 8$$

$$9. x = 3$$

$$10. x = -12$$

$$11. x = \frac{40}{9}$$

$$12. x = 30$$

$$13. x = 6$$

$$14. x = 1.5$$

$$15. x = 2$$

$$16. x = 3$$

$$17. x = 9$$

$$18. x = 4$$

$$19. x = -2$$

$$20. x = 1$$

SOLVING QUADRATICS BY COMPLETING THE SQUARE

#24

If $(x - a)^2 = b$, then $(x - a) = \pm\sqrt{b}$ and $x = a \pm \sqrt{b}$. This means that if we have a perfect square on one side of an equation we can remove it by taking the square root of each side and then solving in the usual way. Completing the square is a method to transform a quadratic equation into this sometimes more usable form. Also see the textbook, pages 436-38 and 444.

Example 1

Solve $x^2 - 10x + 22 = 0$

Isolate the constant.

$$x^2 - 10x = -22$$

We need to make $x^2 - 10x$ into a perfect square. Taking half the x coefficient and squaring it will accomplish this.

$$(x^2 - 10x + ?) = -22, \quad ? = \left(\frac{-10}{2}\right)^2 = 25$$

The 25 that was put into the parenthesis must be compensated for by adding 25 to the other side so that the equation remains balanced.

$$(x^2 - 10x + 25) = -22 + 25$$

Factor and simplify.

$$\begin{aligned}(x - 5)^2 &= 3 \\ x - 5 &= \pm\sqrt{3} \\ x &= 5 \pm \sqrt{3}\end{aligned}$$

Example 2

Solve $x^2 + 5x + 2 = 0$

Isolate the 2.

$$x^2 + 5x = -2$$

We need to make $x^2 + 5x$ into a perfect square. Again, taking half of the x coefficient and squaring the result will accomplish the task.

$$(x^2 + 5x + ?) = -2, \quad ? = \left(\frac{5}{2}\right)^2 = \frac{25}{4}$$

The $\frac{25}{4}$ that was put into the parenthesis must be compensated for by adding $\frac{25}{4}$ to each side (then factoring and simplifying).

$$(x^2 + 5x + \frac{25}{4}) = -2 + \frac{25}{4}$$

$$(x + \frac{5}{2})^2 = \frac{-8}{4} + \frac{25}{4} = \frac{17}{4}$$

Solve the equation as usual.

$$(x + \frac{5}{2}) = \pm\sqrt{\frac{17}{4}} = \pm\frac{\sqrt{17}}{2}$$

$$x = \frac{-5}{2} \pm \frac{\sqrt{17}}{2} \text{ or } \frac{-5 \pm \sqrt{17}}{2}$$

Solve the following quadratics by completing the square.

1. $x^2 - 2x - 20 = 0$

2. $x^2 - 8x - 10 = 0$

3. $x^2 + 12x = -3$

4. $y^2 + 10y = -7$

5. $x^2 + 4x - 3 = 0$

6. $y^2 + 14y + 5 = 0$

7. $y^2 - 3y = -2$

8. $m^2 - 9m - 4 = 3$

9. $w^2 + w = 5$

10. $x^2 - x - 20 = 0$

11. $4x^2 + 4x + 1 = 5$

12. $2x^2 + 12x = 18$

Answers

1. $1 \pm \sqrt{21}$

2. $4 \pm \sqrt{26}$

3. $-6 \pm \sqrt{33}$

4. $-5 \pm \sqrt{18}$

5. $-2 \pm \sqrt{7}$

6. $-7 \pm \sqrt{44}$

7. 2, 1

8. $\frac{9 \pm \sqrt{109}}{2}$

9. $\frac{9 \pm \sqrt{109}}{2}$

10. 5, -4

11. $\frac{-1 \pm \sqrt{5}}{2}$

12. $-3 \pm \sqrt{18}$

LAWS OF EXPONENTS

#25

BASE, EXPONENT, AND VALUE

In the expression 2^5 , 2 is the **base**, 5 is the **exponent**, and the **value** is 32.

2^5 means $2 \cdot 2 \cdot 2 \cdot 2 \cdot 2 = 32$

x^3 means $x \cdot x \cdot x$

LAWS OF EXPONENTS

Here are the basic patterns with examples:

- $x^a \cdot x^b = x^{a+b}$ examples: $x^3 \cdot x^4 = x^{3+4} = x^7$; $2^7 \cdot 2^4 = 2^{11}$
- $\frac{x^a}{x^b} = x^{a-b}$ examples: $x^{10} \div x^4 = x^{10-4} = x^6$; $\frac{2^4}{2^7} = 2^{-3}$ or $\frac{1}{2^3}$
- $(x^a)^b = x^{ab}$ examples: $(x^4)^3 = x^{4 \cdot 3} = x^{12}$; $(2x^3)^4 = 2^4 \cdot x^{12} = 16x^{12}$
- $x^{-a} = \frac{1}{x^a}$ and $\frac{1}{x^{-b}} = x^b$ examples: $3x^{-3}y^2 = \frac{3y^2}{x^3}$; $\frac{2x^5}{y^{-2}} = 2x^5y^2$
- $x^0 = 1$ examples: $5^0 = 1$; $(2x)^0 = 1$

Also see the textbook, pages 442-52.

Example 1

Simplify: $(2xy^3)(5x^2y^4)$

Multiply the coefficients: $2 \cdot 5 \cdot xy^3 \cdot x^2y^4 = 10xy^3 \cdot x^2y^4$

Add the exponents of x , then y : $10x^{1+2}y^{3+4} = 10x^3y^7$

Example 2

Simplify: $\frac{14x^2y^{12}}{7x^5y^7}$

Divide the coefficients: $\frac{(14 \div 7)x^2y^{12}}{x^5y^7} = \frac{2x^2y^{12}}{x^5y^7}$

Subtract the exponents: $2x^{2-5}y^{12-7} = 2x^{-3}y^5$ OR $\frac{2y^5}{x^3}$

Example 3

Simplify: $(3x^2y^4)^3$

Cube each factor: $3^3 \cdot (x^2)^3 \cdot (y^4)^3 = 27(x^2)^3(y^4)^3$

Multiply the exponents: $27x^6y^{12}$

Example 4

Simplify: $3x^{-4}y^2z^{-3} \Rightarrow \frac{3y^2}{x^4z^3}$

Simplify each expression:

- | | | | |
|------------------------------|---------------------------------------|---|---|
| 1. $y^5 \cdot y^7$ | 2. $b^4 \cdot b^3 \cdot b^2$ | 3. $8^6 \cdot 8^2$ | 4. $(y^5)^2$ |
| 5. $(3a)^4$ | 6. $\frac{m^8}{m^3}$ | 7. $\frac{12x^9}{4x^4}$ | 8. $(x^3y^2)^3$ |
| 9. $\frac{(y^4)^2}{(y^3)^2}$ | 10. $\frac{15x^2y^7}{3x^4y^5}$ | 11. $(4c^4)(ac^3)(3a^5c)$ | 12. $(7x^3y^5)^2$ |
| 13. $(4xy^2)(2y)^3$ | 14. $\left(\frac{4}{x^2}\right)^3$ | 15. $\frac{(2a^7)(3a^2)}{6a^3}$ | 16. $\left(\frac{5m^3n}{m^5}\right)^3$ |
| 17. $(3a^2x^3)^2(2ax^4)^3$ | 18. $\left(\frac{x^3y}{y^4}\right)^4$ | 19. $\left(\frac{6y^2x^8}{12x^3y^7}\right)^2$ | 20. $\frac{(2x^5y^3)^3(4xy^4)^2}{8x^7y^{12}}$ |

Write the following expressions without negative exponents.

- | | | | |
|--------------|-----------------|--------------------------|------------------|
| 21. x^{-2} | 22. $y^{-3}y^2$ | 23. $\frac{x^5}{x^{-2}}$ | 24. $(y^{-2})^5$ |
|--------------|-----------------|--------------------------|------------------|

Note: More practice with negative exponents is available in Extra Practice #21.

Answers

- | | | | |
|---------------------|-----------------------------|------------------------------|--------------------------|
| 1. y^{12} | 2. b^9 | 3. 8^8 | 4. y^{10} |
| 5. $81a^4$ | 6. m^5 | 7. $3x^5$ | 8. x^9y^6 |
| 9. y^2 | 10. $\frac{5y^2}{x^2}$ | 11. $12a^6c^8$ | 12. $49x^6y^{10}$ |
| 13. $32xy^5$ | 14. $\frac{64}{x^6}$ | 15. a^6 | 16. $\frac{125n^3}{m^6}$ |
| 17. $72a^7x^{18}$ | 18. $\frac{x^{12}}{y^{12}}$ | 19. $\frac{x^{10}}{4y^{10}}$ | 20. $16x^{10}y^5$ |
| 21. $\frac{1}{x^2}$ | 22. $\frac{1}{y}$ | 23. x^7 | 24. $\frac{1}{y^{10}}$ |

ADDITION AND SUBTRACTION OF RATIONAL EXPRESSIONS**#26**

Addition and subtraction of rational expressions is done the same way as addition and subtraction of numerical fractions. Change to a common denominator (if necessary), combine the numerators, and then simplify. Also see the textbook, pages 499-503.

Example 1

The Least Common Multiple (lowest common denominator) of $(x + 3)(x + 2)$ and $(x + 2)$ is $(x + 3)(x + 2)$.

$$\frac{4}{(x + 2)(x + 3)} + \frac{2x}{x + 2}$$

The denominator of the first fraction already is the Least Common Multiple. To get a common denominator in the second fraction, multiply the fraction by $\frac{x+3}{x+3}$, a form of one (1).

$$\frac{4}{(x + 2)(x + 3)} + \frac{2x}{x + 2} \cdot \frac{(x + 3)}{(x + 3)}$$

Multiply the numerator and denominator of the second term.

$$\frac{4}{(x + 2)(x + 3)} + \frac{2x(x + 3)}{(x + 2)(x + 3)}$$

Distribute in the second numerator.

$$\frac{4}{(x + 2)(x + 3)} + \frac{2x^2 + 6x}{(x + 2)(x + 3)}$$

Add, factor, and simplify. Note $x \neq -2$ or -3 .

$$\frac{2x^2 + 6x + 4}{(x + 2)(x + 3)} = \frac{2(x + 1)(x + 2)}{(x + 2)(x + 3)} = \frac{2(x + 1)}{(x + 3)}$$

Example 2

Subtract $\frac{3}{x-1} - \frac{2}{x-2}$ and simplify the result.

Find the lowest common denominator of $(x - 1)$ and $(x - 2)$. It is $(x - 1)(x - 2)$.

In order to change each denominator into the lowest common denominator, we need to multiply each fraction by factors that are equal to one.

$$\frac{(x-2)}{(x-2)} \cdot \frac{3}{x-1} - \frac{2}{(x-2)} \cdot \frac{(x-1)}{(x-1)}$$

Multiply the denominators.

$$\frac{3(x-2)}{(x-2)(x-1)} - \frac{2(x-1)}{(x-2)(x-1)}$$

Multiply and distribute the numerators.

$$\frac{3x-6}{(x-2)(x-1)} - \frac{2x-2}{(x-2)(x-1)}$$

When adding fractions, the denominator does not change. The numerators need to be added or subtracted and like terms combined.

$$\frac{3x-6-(2x-2)}{(x-2)(x-1)} \Rightarrow \frac{3x-6-2x+2}{(x-2)(x-1)} \Rightarrow \frac{x-4}{(x-2)(x-1)}$$

Check that both the numerator and denominator are completely factored. If the answer can be simplified, simplify it. This answer is already simplified. Note: $x \neq 1$ or 2 .

$$\frac{x-4}{(x-2)(x-1)} = \frac{x-4}{x^2-3x+2}$$

Add or subtract the expressions and simplify the result. Assume that none of the denominators equal zero.

$$1. \frac{x}{(x+2)(x+3)} + \frac{2}{(x+2)(x+3)}$$

$$2. \frac{x}{x^2+6x+8} + \frac{4}{x^2+6x+8}$$

$$3. \frac{b^2}{b^2+2b-3} + \frac{-9}{b^2+2b-3}$$

$$4. \frac{2a}{a^2+2a+1} + \frac{2}{a^2+2a+1}$$

$$5. \frac{x+10}{x+2} + \frac{x-6}{x+2}$$

$$6. \frac{a+2b}{a+b} + \frac{2a+b}{a+b}$$

$$7. \frac{3x-4}{3x+3} - \frac{2x-5}{3x+3}$$

$$8. \frac{3x}{4x-12} - \frac{9}{4x-12}$$

$$9. \frac{6a}{5a^2+a} - \frac{a-1}{5a^2+a}$$

$$10. \frac{x^2+3x-5}{10} - \frac{x^2-2x+10}{10}$$

$$11. \frac{6}{x(x+3)} + \frac{2}{x+3}$$

$$12. \frac{5}{x-7} + \frac{3}{4(x-7)}$$

$$13. \frac{5x+6}{x^2} - \frac{5}{x}$$

$$14. \frac{2}{x+4} - \frac{x-4}{x^2-16}$$

$$15. \frac{10a}{a^2+6a} - \frac{3}{3a+18}$$

$$16. \frac{3x}{2x^2-8x} + \frac{2}{(x-4)}$$

$$17. \frac{5x+9}{x^2-2x-3} + \frac{6}{x^2-7x+12}$$

$$18. \frac{x+4}{x^2-3x-28} - \frac{x-5}{x^2+2x-35}$$

$$19. \frac{3x+1}{x^2-16} - \frac{3x+5}{x^2+8x+16}$$

$$20. \frac{7x-1}{x^2-2x-3} - \frac{6x}{x^2-x-2}$$

Answers

$$1. \frac{1}{x+3}$$

$$2. \frac{1}{x+2}$$

$$3. \frac{b-3}{b-1}$$

$$4. \frac{2}{a+1}$$

$$5. 2$$

$$6. 3$$

$$7. \frac{1}{3}$$

$$8. \frac{3}{4}$$

$$9. \frac{1}{a}$$

$$10. \frac{x-3}{2}$$

$$11. \frac{2}{x}$$

$$12. \frac{23}{4(x-7)} = \frac{23}{4x-28}$$

$$13. \frac{6}{x^2}$$

$$14. \frac{1}{x+4}$$

$$15. \frac{9}{(a+6)}$$

$$16. \frac{7}{2(x-4)} = \frac{7}{2x-8}$$

$$17. \frac{5(x+2)}{(x-4)(x+1)} = \frac{5x+10}{x^2-3x-4}$$

$$18. \frac{14}{(x+7)(x-7)} = \frac{14}{x^2-49}$$

$$19. \frac{4(5x+6)}{(x-4)(x+4)^2}$$

$$20. \frac{x+2}{(x-3)(x-2)} = \frac{x+2}{x^2-5x+6}$$

SOLVING MIXED EQUATIONS AND INEQUALITIES**#27**

Solve these various types of equations.

- | | | |
|--------------------------------------|---|--|
| 1. $2(x - 3) + 2 = -4$ | 2. $6 - 12x = 108$ | 3. $3x - 11 = 0$ |
| 4. $0 = 2x - 5$ | 5. $y = 2x - 3$
$x + y = 15$ | 6. $ax - b = 0$
(solve for x) |
| 7. $0 = (2x - 5)(x + 3)$ | 8. $2(2x - 1) = -x + 5$ | 9. $x^2 + 5^2 = 13^2$ |
| 10. $2x + 1 = 7x - 15$ | 11. $\frac{5-2x}{3} = \frac{x}{5}$ | 12. $2x - 3y + 9 = 0$
(solve for y) |
| 13. $x^2 + 5x + 6 = 0$ | 14. $x^2 = y$
$100 = y$ | 15. $x - y = 7$
$y = 2x - 1$ |
| 16. $x^2 - 4x = 0$ | 17. $x^2 - 6 = -2$ | 18. $\frac{x}{2} + \frac{x}{3} = 2$ |
| 19. $x^2 + 7x + 9 = 3$ | 20. $y = x + 3$
$x + 2y = 3$ | 21. $3x^2 + 7x + 2 = 0$ |
| 22. $\frac{x}{x+1} = \frac{5}{7}$ | 23. $x^2 + 2x - 4 = 0$ | 24. $\frac{1}{x} + \frac{1}{3x} = 2$ |
| 25. $3x + y = 5$
$x - y = 11$ | 26. $y = -\frac{3}{4}x + 4$
$\frac{1}{4}x - y = 8$ | 27. $3x^2 = 8x$ |
| 28. $ x = 4$ | 29. $\frac{2}{3}x + 1 = \frac{1}{2}x - 3$ | 30. $x^2 - 4x = 5$ |
| 31. $3x + 5y = 15$
(solve for y) | 32. $(3x)^2 + x^2 = 15^2$ | 33. $y = 11$
$y = 2x^2 + 3x - 9$ |
| 34. $(x + 2)(x + 3)(x - 4) = 0$ | 35. $ x + 6 = 8$ | 36. $2(x + 3) = y + 2$
$y + 2 = 8x$ |
| 37. $2x + 3y = 13$
$x - 2y = -11$ | 38. $2x^2 = -x + 7$ | 39. $1 - \frac{5}{6x} = \frac{x}{6}$ |
| 40. $\frac{x-1}{5} = \frac{3}{x+1}$ | 41. $\sqrt{2x+1} = 5$ | 42. $2 2x-1 + 3 = 7$ |
| 43. $\sqrt{3x-1} + 1 = 7$ | 44. $(x + 3)^2 = 49$ | 45. $\frac{4x-1}{x-1} = x + 1$ |

Solve these various types of inequalities.

46. $4x - 2 \leq 6$

47. $4 - 3(x + 2) \geq 19$

48. $\frac{x}{2} > \frac{3}{7}$

49. $3(x + 2) \geq -9$

50. $-\frac{2}{3}x < 6$

51. $y < 2x - 3$

52. $|x| > 4$

53. $x^2 - 6x + 8 \leq 0$

54. $|x + 3| > 5$

55. $2x^2 - 4x \geq 0$

56. $y \leq -\frac{2}{3}x + 2$

57. $y \leq -x + 2$
 $y \leq 3x - 6$

58. $|2x - 1| \leq 9$

59. $5 - 3(x - 1) \geq -x + 2$

60. $y \leq 4x + 16$
 $y > -\frac{4}{3}x - 4$

Answers

1. 0

2. -8.5

3. $\frac{11}{3}$

4. $\frac{5}{2}$

5. (6, 9)

6. $x = \frac{b}{a}$

7. $\frac{5}{2}, -3$

8. $\frac{7}{5}$

9. ± 12

10. $\frac{16}{5}$

11. $\frac{25}{13}$

12. $y = \frac{2}{3}x + 3$

13. -2, -3

14. $(\pm 10, 100)$

15. (-6, -13)

16. 0, 4

17. ± 2

18. $\frac{12}{5}$

19. -1, -6

20. (-1, 2)

21. $\frac{1}{3}, -2$

22. $\frac{5}{2}$

23. $\frac{-2 \pm \sqrt{20}}{2}$

24. $\frac{2}{3}$

25. (4, -7)

26. (12, -5)

27. $0, \frac{8}{3}$

28. ± 4

29. -24

30. 5, -1

31. $y = -\frac{3}{5}x + 3$

32. $\approx \pm 4.74$

33. (-4, 11) and $(\frac{5}{2}, 11)$

34. -2, -3, 4

35. 2, -14

36. (1, 6)

37. (-1, 5)

38. $\frac{1 \pm \sqrt{57}}{4}$

39. 1, 5

40. ± 4

41. 12

42. $\frac{3}{2}, -\frac{1}{2}$

43. $\frac{37}{3}$

44. 4, -10

45. 0, 4

46. $x \leq 2$

47. $x \leq -7$

48. $x > \frac{6}{7}$

49. $x \geq -5$

50. $x > -9$

51. see below

52. $x > 4, x < -4$

53. $2 \leq x \leq 4$

54. $x > 2$ or $x < -8$

55. $x \leq 0$ or $x \geq 2$

56. see below

57. see below

58. $-4 \leq x \leq 5$

59. $x \leq 3$

60. see below

51.

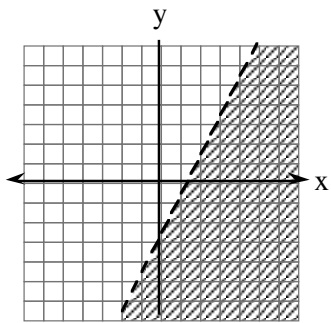

56.

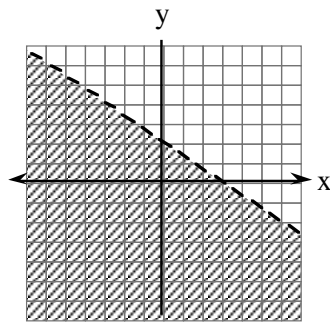

57.

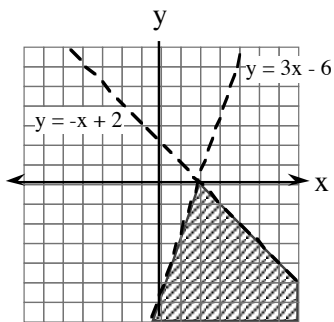

60.

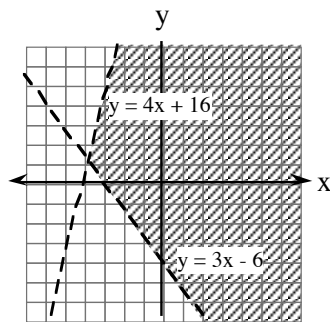

PYTHAGOREAN THEOREM

#28

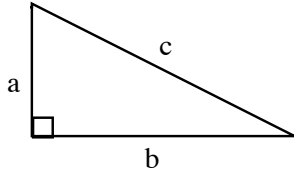

Any triangle that has a right angle is called a **right triangle**. The two sides that form the right angle, a and b , are called **legs**, and the side opposite (that is, across the triangle from) the right angle, c , is called the **hypotenuse**.

For any right triangle, the sum of the squares of the legs of the triangle is equal to the square of the hypotenuse, that is, $a^2 + b^2 = c^2$. This relationship is known as the **Pythagorean Theorem**. In words, the theorem states that:

$$(\text{leg})^2 + (\text{leg})^2 = (\text{hypotenuse})^2.$$

Example

Draw a diagram, then use the Pythagorean Theorem to write an equation to solve each problem.

a) Solve for the missing side.

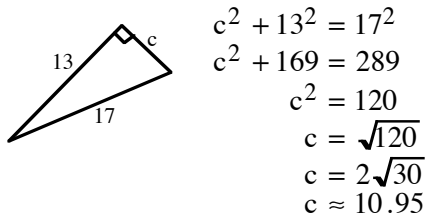

b) Find x to the nearest tenth:

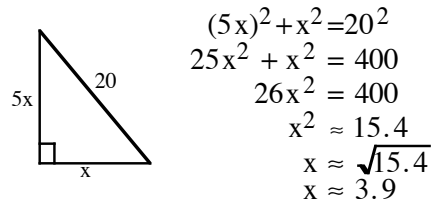

c) One end of a ten foot ladder is four feet from the base of a wall. How high on the wall does the top of the ladder touch?

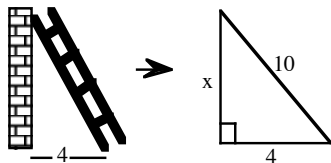

$$x^2 + 4^2 = 10^2$$

$$x^2 + 16 = 100$$

$$x^2 = 84$$

$$x \approx 9.2$$

The ladder touches the wall about 9.2 feet above the ground.

d) Could 3, 6 and 8 represent the lengths of the sides of a right triangle? Explain.

$$3^2 + 6^2 \stackrel{?}{=} 8^2$$

$$9 + 36 \stackrel{?}{=} 64$$

$$45 \neq 64$$

Since the Pythagorean Theorem relationship is not true for these lengths, they cannot be the side lengths of a right triangle.

Write an equation and solve for each unknown side. Round to the nearest hundredth.

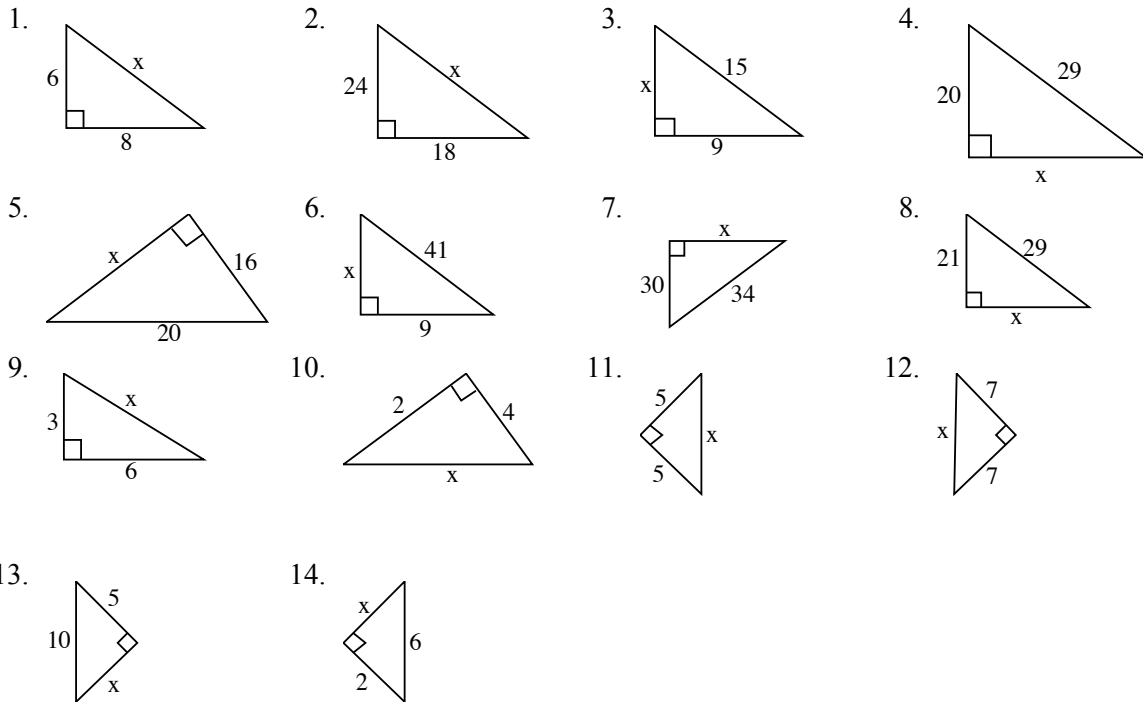

Be careful! Remember to square the whole side. For example, $(2x)^2 = (2x)(2x) = 4x^2$.

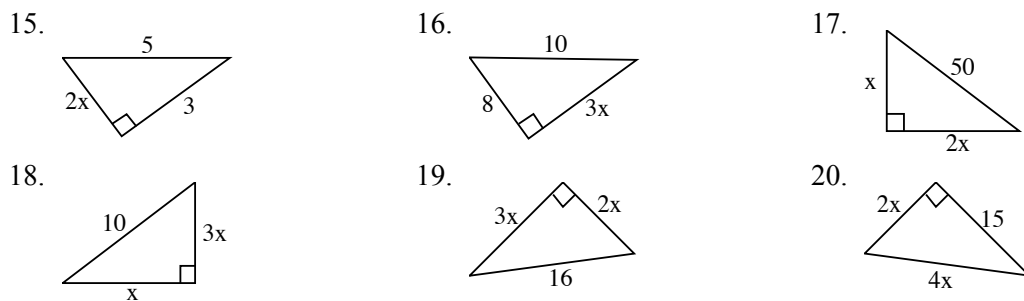

For each of the following problems draw and label a diagram. Then write an equation using the Pythagorean Theorem and solve for the unknown. Round answers to the nearest hundredth.

21. In a right triangle, the length of the hypotenuse is four inches. The length of one leg is two inches. Find the length of the other leg.
22. The length of the hypotenuse of a right triangle is six cm. The length of one leg is four cm. Find the length of the other leg.
23. Find the diagonal length of a television screen 30 inches wide by 20 inches long.
24. Find the length of a path that runs diagonally across a 53 yard by 100 yard field.

25. A mover must put a circular mirror two meters in diameter through a one meter by 1.8 meter doorway. Find the length of the diagonal of the doorway. Will the mirror fit?
26. A surveyor walked eight miles north, then three miles west. How far was she from her starting point?
27. A four meter ladder is one meter from the base of a building. How high up the building will the ladder reach?
28. A 12-meter loading ramp rises to the edge of a warehouse doorway. The bottom of the ramp is nine meters from the base of the warehouse wall. How high above the base of the wall is the doorway?
29. What is the longest line you can draw on a paper that is 15 cm by 25 cm?
30. How long an umbrella will fit in the bottom of a suitcase that is 2.5 feet by 3 feet?
31. How long a guy wire is needed to support a 10 meter tall tower if it is fastened five meters from the foot of the tower?
32. Find the diagonal distance from one corner of a 30 foot square classroom floor to the other corner of the floor.
33. Harry drove 10 miles west, then five miles north, then three miles west. How far was he from his starting point?
34. Linda can turn off her car alarm from 20 yards away. Will she be able to do it from the far corner of a 15 yard by 12 yard parking lot?
35. The hypotenuse of a right triangle is twice as long as one of its legs. The other leg is nine inches long. Find the length of the hypotenuse.
36. One leg of a right triangle is three times as long as the other. The hypotenuse is 100 cm. Find the length of the shorter leg.

Answers

1. $x = 10$
2. $x = 30$
3. $x = 12$
4. $x = 21$
5. $x = 12$
6. $x = 40$
7. $x = 16$
8. $x = 20$
9. $x \approx 6.71$
10. $x \approx 4.47$
11. $x \approx 7.07$
12. $x \approx 9.9$
13. $x \approx 8.66$
14. $x \approx 5.66$
15. $x = 2$
16. $x = 2$
17. $x \approx 22.36$
18. $x \approx 3.16$
19. $x \approx 4.44$
20. $x \approx 4.33$
21. 3.46 inches
22. 4.47 cm
23. 36.06 inches
24. 113.18 yards
25. The diagonal is 2.06 meters, so yes.
26. 8.54 miles
27. 3.87 meters
28. 7.94 meters
29. 29.15 cm
30. 3.91 feet
31. 11.18 meters
32. 42.43 feet
33. 13.93 miles
34. The corner is 19.21 yards away so yes!
35. 10.39 inches
36. 31.62 cm

SIMPLIFYING RADICALS

#29

Sometimes it is convenient to leave square roots in radical form instead of using a calculator to find approximations (decimal values). Look for perfect squares (i.e., 4, 9, 16, 25, 36, 49, ...) as **factors** of the number that is inside the radical sign (**radicand**) and take the square root of any perfect square factor. Multiply the root of the perfect square times the reduced radical. When there is an existing value that multiplies the radical, multiply any root(s) times that value.

For example:

$$\sqrt{9} = 3$$

$$5\sqrt{9} = 5 \cdot 3 = 15$$

$$\sqrt{18} = \sqrt{9 \cdot 2} = \sqrt{9} \cdot \sqrt{2} = 3\sqrt{2}$$

$$3\sqrt{98} = 3\sqrt{49 \cdot 2} = 3 \cdot 7\sqrt{2} = 21\sqrt{2}$$

$$\sqrt{80} = \sqrt{16 \cdot 5} = \sqrt{16} \cdot \sqrt{5} = 4\sqrt{5}$$

$$\sqrt{45} + 4\sqrt{20} = \sqrt{9 \cdot 5} + 4\sqrt{4 \cdot 5} = 3\sqrt{5} + 4 \cdot 2\sqrt{5} = 11\sqrt{5}$$

When there are no more perfect square factors inside the radical sign, the product of the whole number (or fraction) and the remaining radical is said to be in **simple radical form**.

Simple radical form does not allow radicals in the denominator of a fraction. If there is a radical in the denominator, **rationalize the denominator** by multiplying the numerator and denominator of the fraction by the radical in the original denominator. Then simplify the remaining fraction. Examples:

$$\frac{2}{\sqrt{2}} = \frac{2}{\sqrt{2}} \cdot \frac{\sqrt{2}}{\sqrt{2}} = \frac{2\sqrt{2}}{2} = \sqrt{2}$$

$$\frac{4\sqrt{5}}{\sqrt{6}} = \frac{4\sqrt{5}}{\sqrt{6}} \cdot \frac{\sqrt{6}}{\sqrt{6}} = \frac{4\sqrt{30}}{6} = \frac{2\sqrt{30}}{3}$$

In the first example, $\sqrt{2} \cdot \sqrt{2} = \sqrt{4} = 2$ and $\frac{2}{2} = 1$. In the second example,

$$\sqrt{6} \cdot \sqrt{6} = \sqrt{36} = 6 \quad \text{and} \quad \frac{4}{6} = \frac{2}{3}.$$

The rules for radicals used in the above examples are shown below. Assume that the variables represent non-negative numbers.

$$(1) \quad \sqrt{x} \cdot \sqrt{y} = \sqrt{xy}$$

$$(2) \quad \sqrt{x \cdot y} = \sqrt{x} \cdot \sqrt{y}$$

$$(3) \quad \frac{\sqrt{x}}{\sqrt{y}} = \sqrt{\frac{x}{y}}$$

$$(4) \quad \sqrt{x^2} = (\sqrt{x})^2 = x$$

$$(5) \quad a\sqrt{x} + b\sqrt{x} = (a + b)\sqrt{x}$$

Write each expression in simple radical (square root) form.

- | | | | |
|------------------------------------|------------------------------------|----------------------------------|----------------------------------|
| 1. $\sqrt{32}$ | 2. $\sqrt{28}$ | 3. $\sqrt{54}$ | 4. $\sqrt{68}$ |
| 5. $2\sqrt{24}$ | 6. $5\sqrt{90}$ | 7. $6\sqrt{132}$ | 8. $5\sqrt{200}$ |
| 9. $2\sqrt{6} \cdot 3\sqrt{2}$ | 10. $3\sqrt{12} \cdot 2\sqrt{3}$ | 11. $\frac{\sqrt{12}}{\sqrt{3}}$ | 12. $\frac{\sqrt{20}}{\sqrt{5}}$ |
| 13. $\frac{8\sqrt{12}}{2\sqrt{3}}$ | 14. $\frac{14\sqrt{8}}{7\sqrt{2}}$ | 15. $\frac{2}{\sqrt{3}}$ | 16. $\frac{4}{\sqrt{5}}$ |
| 17. $\frac{6}{\sqrt{3}}$ | 18. $\frac{2\sqrt{3}}{\sqrt{6}}$ | 19. $2\sqrt{3} + 3\sqrt{12}$ | 20. $4\sqrt{12} - 2\sqrt{3}$ |
| 21. $6\sqrt{3} + 2\sqrt{27}$ | 22. $2\sqrt{45} - 2\sqrt{5}$ | 23. $2\sqrt{8} - \sqrt{18}$ | 24. $3\sqrt{48} - 4\sqrt{27}$ |

Answers

- | | | | | |
|---------------------------|------------------|-----------------|-----------------|---------------------------|
| 1. $4\sqrt{2}$ | 2. $2\sqrt{7}$ | 3. $3\sqrt{6}$ | 4. $2\sqrt{17}$ | 5. $4\sqrt{6}$ |
| 6. $15\sqrt{10}$ | 7. $12\sqrt{33}$ | 8. $50\sqrt{2}$ | 9. $12\sqrt{3}$ | 10. 36 |
| 11. 2 | 12. 2 | 13. 8 | 14. 4 | 15. $\frac{2\sqrt{3}}{3}$ |
| 16. $\frac{4\sqrt{5}}{5}$ | 17. $2\sqrt{3}$ | 18. $\sqrt{2}$ | 19. $8\sqrt{3}$ | 20. $6\sqrt{3}$ |
| 21. $12\sqrt{3}$ | 22. $4\sqrt{5}$ | 23. $\sqrt{2}$ | 24. 0 | |

PROBLEMS INVOLVING: RATE, WORK, OR PERCENT MIXTURE #30

Rate problems are solved using the concept that distance equals the product of the rate and the time, $D = RT$ and many times drawing a diagram is the key to writing the equation.

Work problems are solved using the concept that if a job can be completed in r units of time, then its rate (or fraction of the job completed) is $\frac{1}{r}$.

Mixture problems are solved using the concept that the product (value or percentage) \times (quantity) must be consistent throughout the equation.

Examples of Rate Problems

Carol and Jan leave from the same place and travel on the same road. Carol walks at a rate of two miles per hour. Carol left five hours earlier than Jan, but Jan bikes at a rate of six miles per hour. When will Jan catch up? Make a diagram:

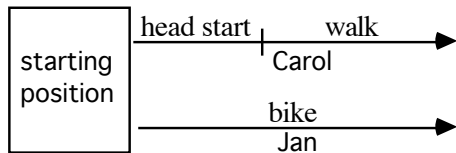

Solution:

Carol has a head start of 10 miles. Let x represent the time Carol travels after the head start. Then her distance traveled after the head start is $2x$ and her total distance traveled is $10 + 2x$. Jan's distance is $6x$.

Cleopatra rode an elephant to the outskirts of Rome at two kilometers per hour and then took a chariot back to camp at 10 kilometers per hour. If the total traveling time was 18 hours, how far was it from camp to the outskirts of Rome? Make a diagram:

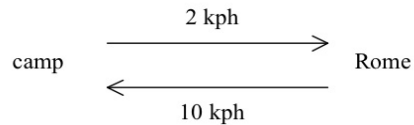

Solution:

Let x represent the time to travel from camp to Rome. Then $2(x)$ is the distance traveled to Rome. If x represents the time from camp, then $18 - x$ represents the return time and $10(18 - x)$ is the return distance.

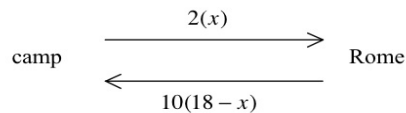

Since both distances are the same:

$$\begin{aligned} 2(x) &= 10(18 - x) \\ 2x &= 180 - 10x \\ 12x &= 180 \end{aligned}$$

$x = 15$ hours and the distance is $2(15) = 30$ km

Examples of Work Problems

Sam can completely deliver all the newspapers on his route in 40 minutes. His brother can do it in 60 minutes. How long will it take them working together?

Solution: Let t = the time to complete the task so $\frac{1}{t}$ is their rate together. John's rate is $\frac{1}{40}$ and his brother's rate is $\frac{1}{60}$. Since they are working together we add the two rates together to get the combined rate.

The equation is $\frac{1}{40} + \frac{1}{60} = \frac{1}{t}$. Solve using fraction busters:

$$120t\left(\frac{1}{40} + \frac{1}{60}\right) = 120t\left(\frac{1}{t}\right)$$

$$3t + 2t = 120$$

$$5t = 120$$

$$t = 24 \text{ minutes}$$

Using two hoses, a swimming pool can be filled in 25 hours. If the faster hose can fill the pool alone in 30 hours, how long would the slower hose take to fill the pool?

Solution: Let t = the time for the slower hose so $\frac{1}{t}$ is its rate. The combined rate is $\frac{1}{25}$ and the faster hose's rate is $\frac{1}{30}$. Since they are working together we add the two rates together to get the combined rate.

The equation is $\frac{1}{30} + \frac{1}{t} = \frac{1}{25}$. Solve using fraction busters:

$$750t\left(\frac{1}{30} + \frac{1}{t}\right) = 750t\left(\frac{1}{25}\right)$$

$$25t + 750 = 30t$$

$$750 = 5t$$

$$t = 150 \text{ hours or } 6.25 \text{ days}$$

Examples of Mixture Problems

Ly has a 30% acid solution and a 60% acid solution. How many liters of each solution should be used to make 200 liters of 50% acid?

Solution: Use $(\%)\cdot(\text{liters}) = (\%)\cdot(\text{liters})$

Let x = liters of 30% acid so $200 - x$ = liters of 60% acid.

The equation is

$$(0.3)\cdot(x) + (0.6)(200 - x) = (0.5)\cdot(200).$$

Multiply by 10 to clear decimals and solve.

$$(3)(x) + (6)(200 - x) = (5)(200)$$

$$3x + 1200 - 6x = 1000$$

$$-3x = -200$$

$$x = 66\frac{2}{3} \text{ liters of 30\% acid}$$

$$\text{so } 133\frac{1}{3} \text{ liters of 60\% acid}$$

A store has 10 pounds of Kona coffee worth \$9.00 a pound and a bag of Maui coffee worth \$6.50 a pound. If the owner wants to make a blend worth \$7.50 a pound, how many pounds of the Maui coffee should be added?

Solution: Use $(\$)\cdot(\text{lbs.}) = (\$)\cdot(\text{lbs.})$

Let x = pounds of Maui coffee
so $x + 10$ = pounds of the blend.

The equation is

$$9.00(10) + 6.50(x) = 7.50(x + 10).$$

Multiply by 100 to clear decimals and solve.

$$900(10) + 650(x) = 750(x + 10)$$

$$9000 + 650x = 750x + 7500$$

$$-100x = -1500$$

$$x = 15 \text{ pounds}$$

Add 15 pounds of Maui coffee.

Solve each problem.

1. Two cars leave Denver in opposite directions. The car traveling west is going 20 miles per hour faster than the car traveling east. If after three hours they are 330 miles apart, how fast is each car traveling?
2. Two friends live 150 miles apart and drive towards each other. One travels 30 miles per hour and the other travels 60 miles per hour. How long will it take before they meet?
3. Two cars leave Atlanta in the same direction but one travels twice as fast as the other. If after five hours they are 275 kilometers apart, how fast is each traveling?
4. Linda rode her bicycle to the park at 15 kilometers per hour but just before she got there she got a flat tire so she had to walk back home at two kilometers per hour. If the total trip took three hours, how far is it to the park?
5. A truck going 70 miles per hour passes a parked highway patrol car. When the truck is half a mile past the patrol car, the officer starts going 100 miles per hour. How long does it take the patrol car to overtake the truck?

6. Janelle can paint her fence in three hours. Her friend Ryan estimates it would take him four hours to paint the same fence. If they work together, how long will it take them to paint Janelle's fence?
7. With one hose a swimming pool can be filled in 10 hours. Another hose can fill it in 12 hours. How long will it take to fill the pool using both hoses?
8. Together, two machines can harvest a wheat crop in six hours. The larger machine can do it alone in eight hours. How long does it take the smaller machine to harvest the crop working alone?
9. Two crews can clean a jumbo-jet in nine hours. The faster crew can clean it in 12 hours alone. How long would the slower crew need to clean the jumbo-jet working alone?
10. Able can harvest a lime crop in four days. Barney can do it in five days. Charlie would take six days. If they all work together, how long will it take them to complete the harvest?
11. Pam's favorite recipe for fruit punch requires 15% apple juice. How much pure apple juice should he add to two gallons of punch that already contains 8% apple juice to meet her standards?
12. Jane has 40 liters of 60% acid solution. How many liters of water must be added to form a solution that is 40% acid?
13. How much tea costing \$8 per pound should be mixed with three pounds of tea costing \$5 per pound to get a mixture costing \$6 per pound?
14. How many liters of water must evaporate from 40 liters of a 10% salt solution to make a 25% salt solution?
15. A candy shop has chocolate pieces that cost \$2.50 per pound and caramel pieces that cost \$1.00 per pound. How many pounds of each should be combined to get 20 pounds of a mixture worth \$2.00 per pound?

Answers

- | | | |
|--------------------------|---------------------------------|--|
| 1. 45 mph, 65 mph | 2. $1\frac{2}{3}$ hours | 3. 55 kph, 110 kph |
| 4. 5 km | 5. $\frac{1}{60}$ hour or 1 min | 6. $\frac{12}{7}$ hours |
| 7. $\frac{60}{11}$ hours | 8. 24 hours | 9. 36 hours |
| 10. $\frac{60}{37}$ days | 11. $\frac{14}{85}$ gallons | 12. 20 liters |
| 13. 7.5 pounds | 14. 24 liters | 15. $13\frac{1}{3}$ lbs chocolate,
$6\frac{2}{3}$ lbs caramel |